

A large, expressive red brushstroke graphic that starts at the top left and sweeps downwards and to the right, crossing through the word 'SPECIALIZED'.

SPECIALIZED

LEAF

TO PROTECT YOU FROM THE WILD
WHILE YOU'RE ACTING WILD

Process Book

WEEK 1

“We were assigned **Specialized** as our brand in Week 1 and worked on a story based on six words over the course of the next six weeks.

This is our pre-midterm presentation about our 6 word story.”

WEEK 6



SPECIALIZED®

*Drifting
Dreamers*

Pandemonium Preacher

Solstice Sanctuary

Jordan M. Moore Sabrina Xu Han Li Benzhe Chen

Drifting

Moving from place to place,
without any fixed home or job.



Dreamers

A group of people who dream and have aspirations.

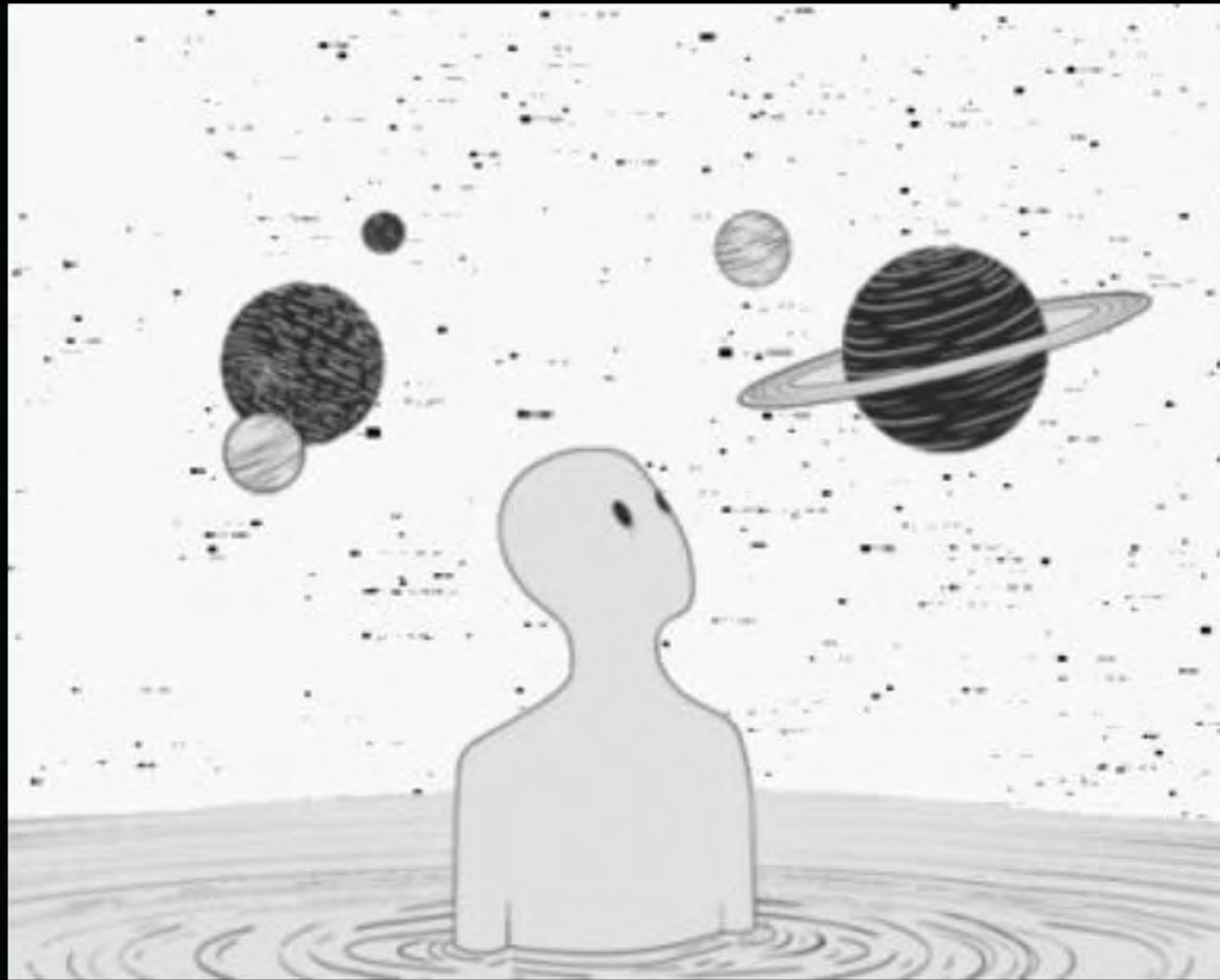

The Drifting Dreamers

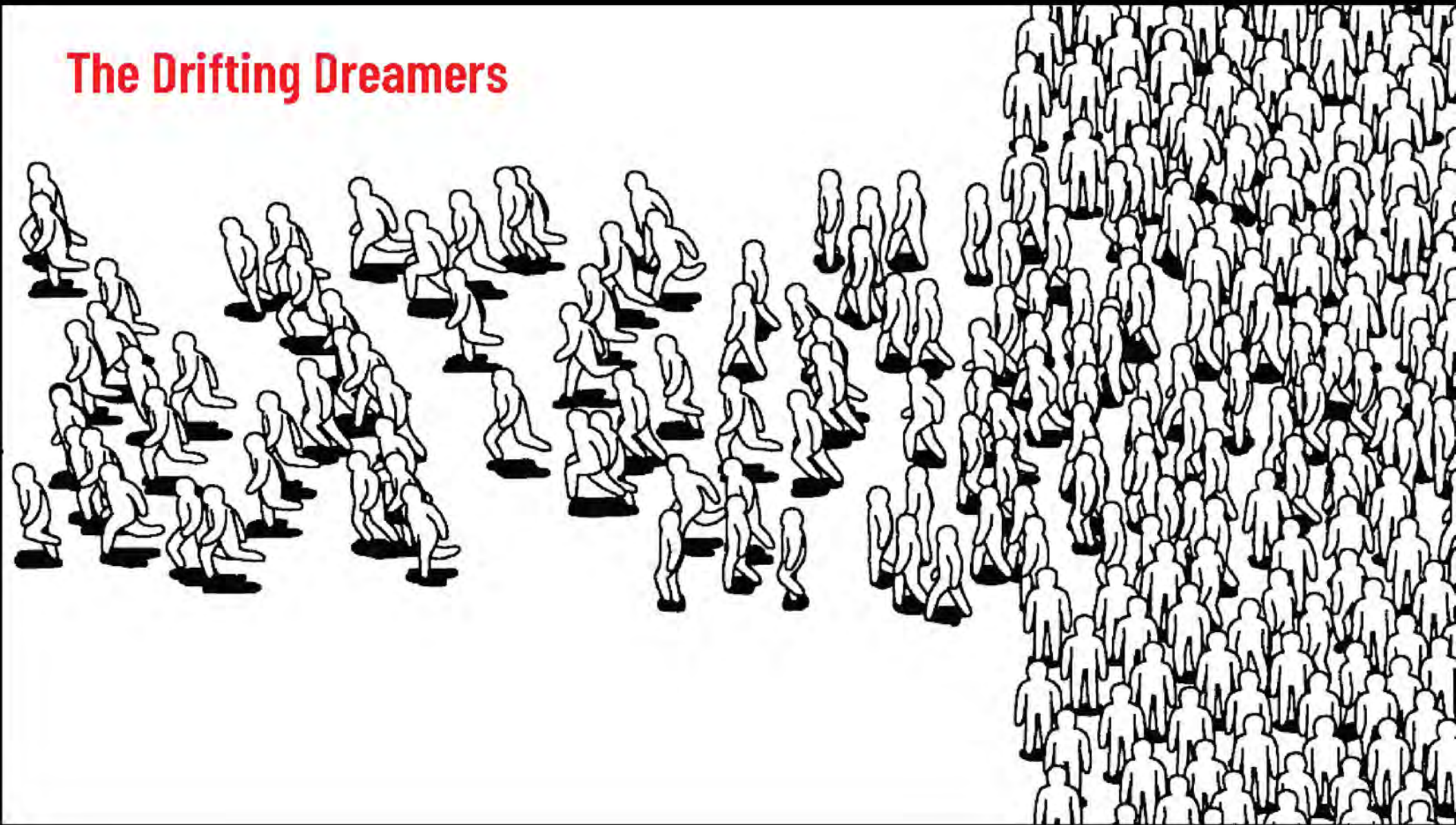

Pandemonium

A wild or noisy confusion, an uproar of thought and emotions



Preacher

Minister of a religion, or a belief.

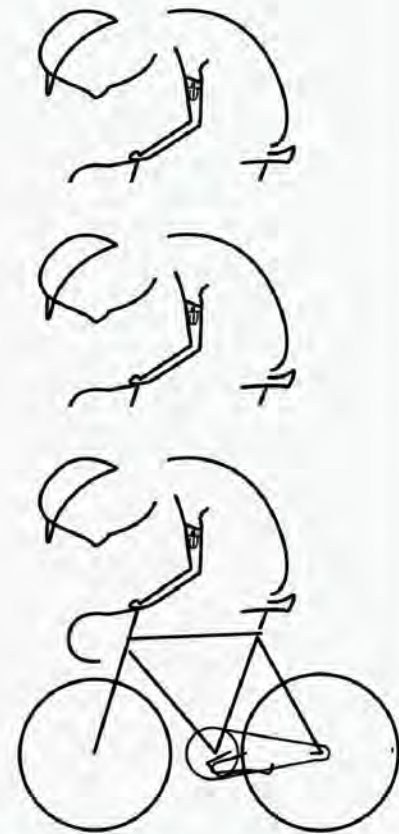
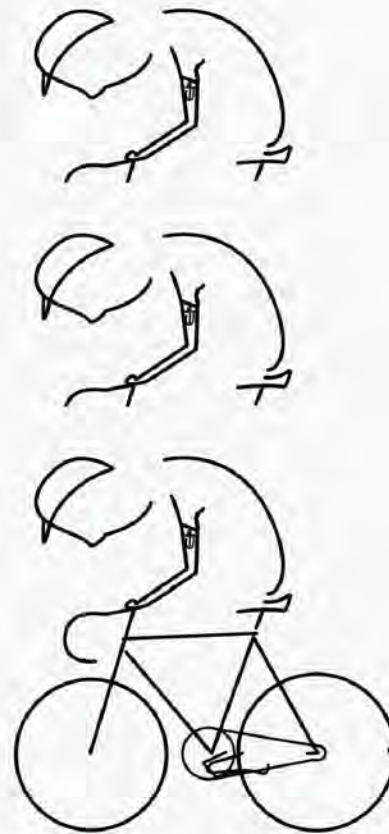

D R I F T I N G
D R E A M E R S



PANDEMONIUM
PREACHER





SOLSTICE
SANCTUARY

The **PREACHER** told them they could be free
in the mountains.

They could be free on the roads.

The **DRIFTERS** were inspired by the **PREACHER**,
they finally understand that the mountains
are their **SANCTUARY**.

When the sun goes down, the first breeze of the night
touches the **DRIFTER'S** face. It flows through their hair.

The **PREACHER** and the **DREAMER** are now one.

They share a common belief.

They are no longer imprisoned.

It was the hottest day of the summer, hot waves rose from the road. The young **DRIFTERS** from the valley were suffering from the heat.

The young **DRIFTERS** from the valley were suffering from the hot weather. They thought they were lost in the hot sunlight.

They thought they were shackled by the mountains.

They were seeking freedom.

They wanted to break out.

However, they didn't know what was possible, or what they were capable of.

This all changed with the arrival of the **PREACHER**.

WEEK 6

IDEATION

“The story was started, and now ideation started based off of the six words and a question of What if..”

WEEK 8



YOU ARE WEAK

I WILL MAKE
YOU
STRONGER

How can we eliminate fear?

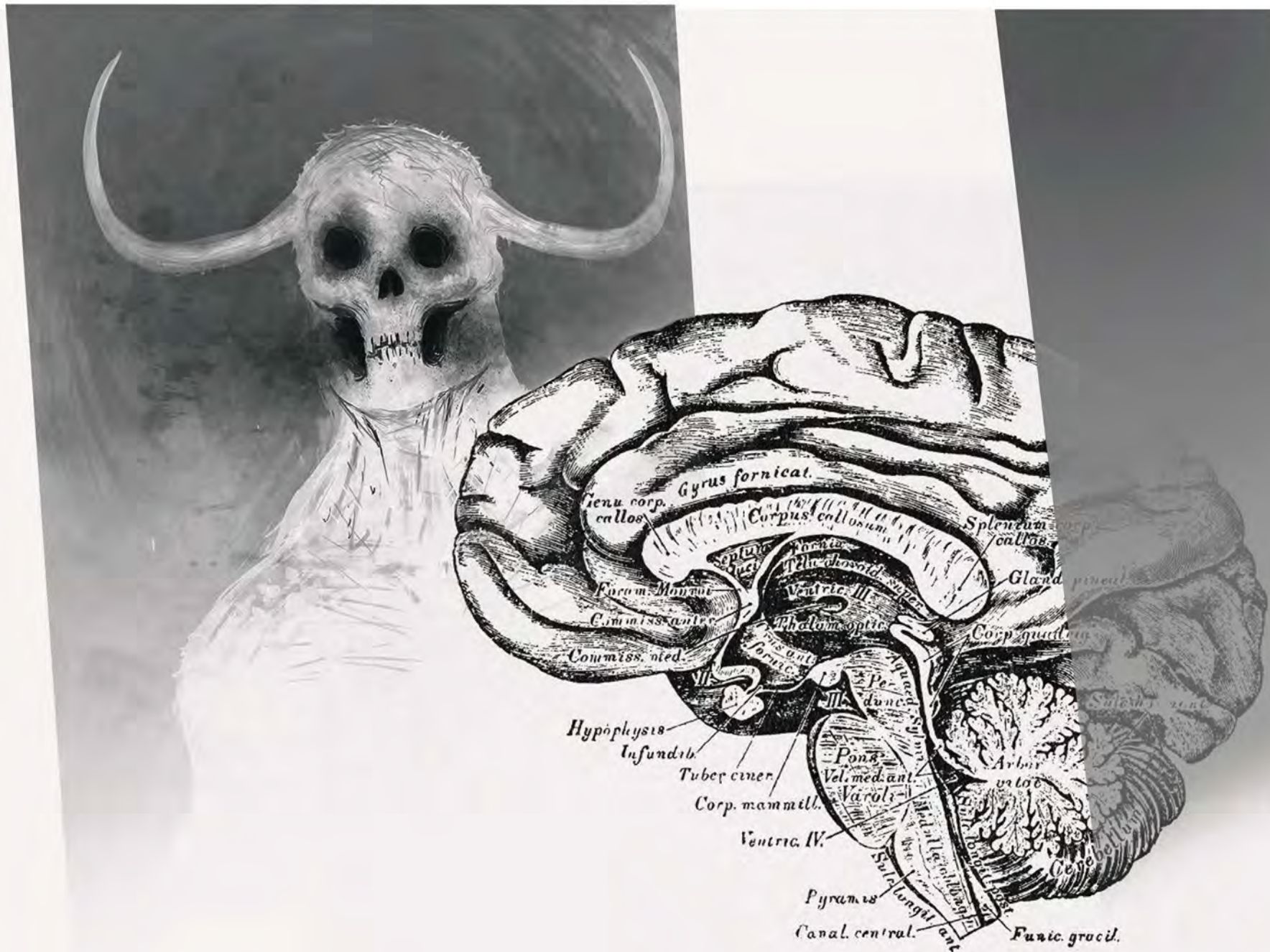



WHAT IF THE EARTH PROTECTED US?

“Eliminating fear led me to further development into new ways of protecting bike riders through making the human body stronger.

I wanted to free them from their homes, so they can go out at night and enjoy the **SANCTUARY** of the cool night on the summer **SOLSTICE**”



How DO WE KILL
SELF DOUBT?

SAFETY

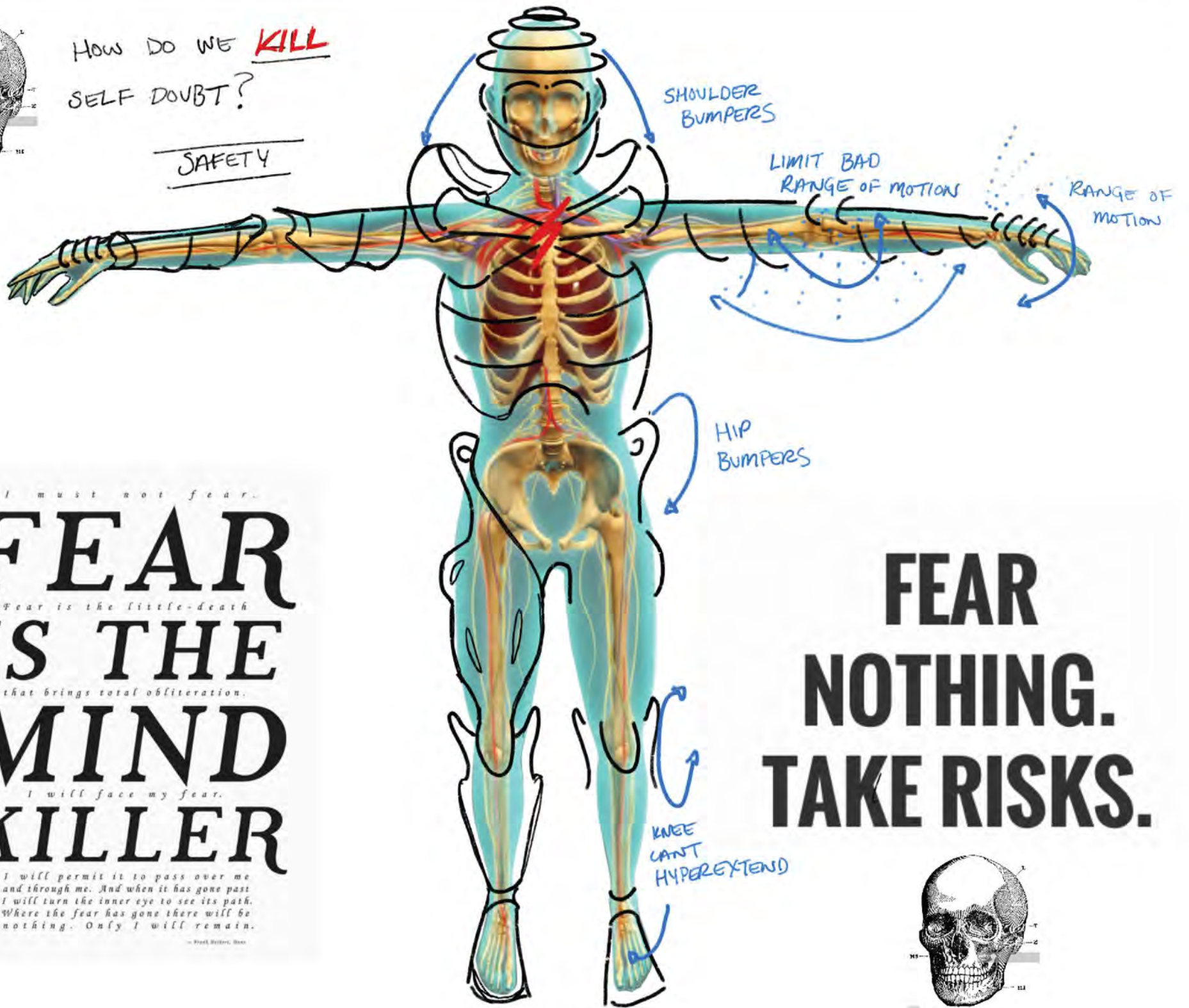

I must not fear.
FEAR
Fear is the little-death
IS THE
that brings total obliteration.
MIND
I will face my fear.
KILLER

*I will permit it to pass over me
and through me. And when it has gone past
I will turn the inner eye to see its path.
Where the fear has gone there will be
nothing. Only I will remain.*

— Frank, Winston, Dan

**FEAR
NOTHING.
TAKE RISKS.**



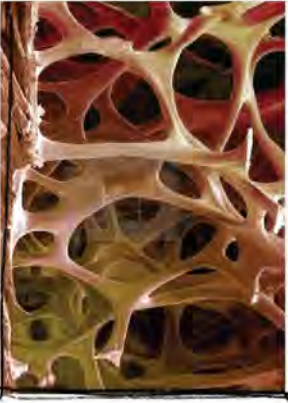

LIGHT WEIGHT
STRONG

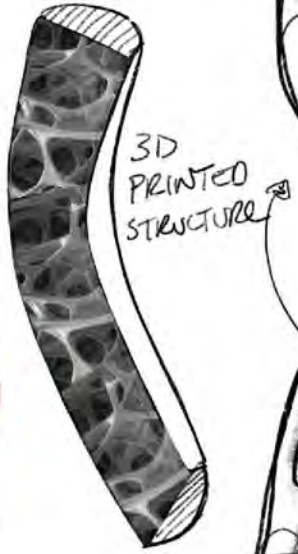

Bird bone structure

SHOULDER
PLATE

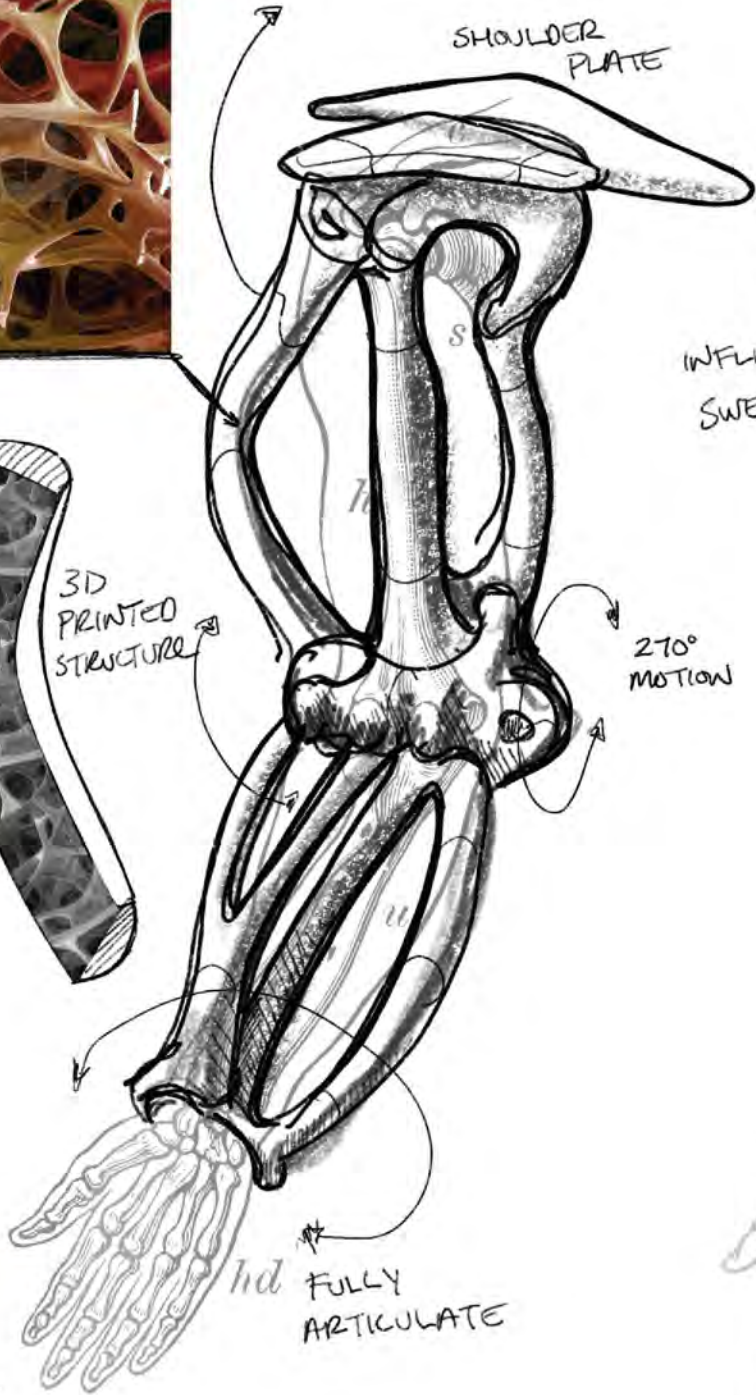

INFLATE?
SWELL?

"MUSCLES" GROW WITH MORE
DANGEROUS BEHAVIOR

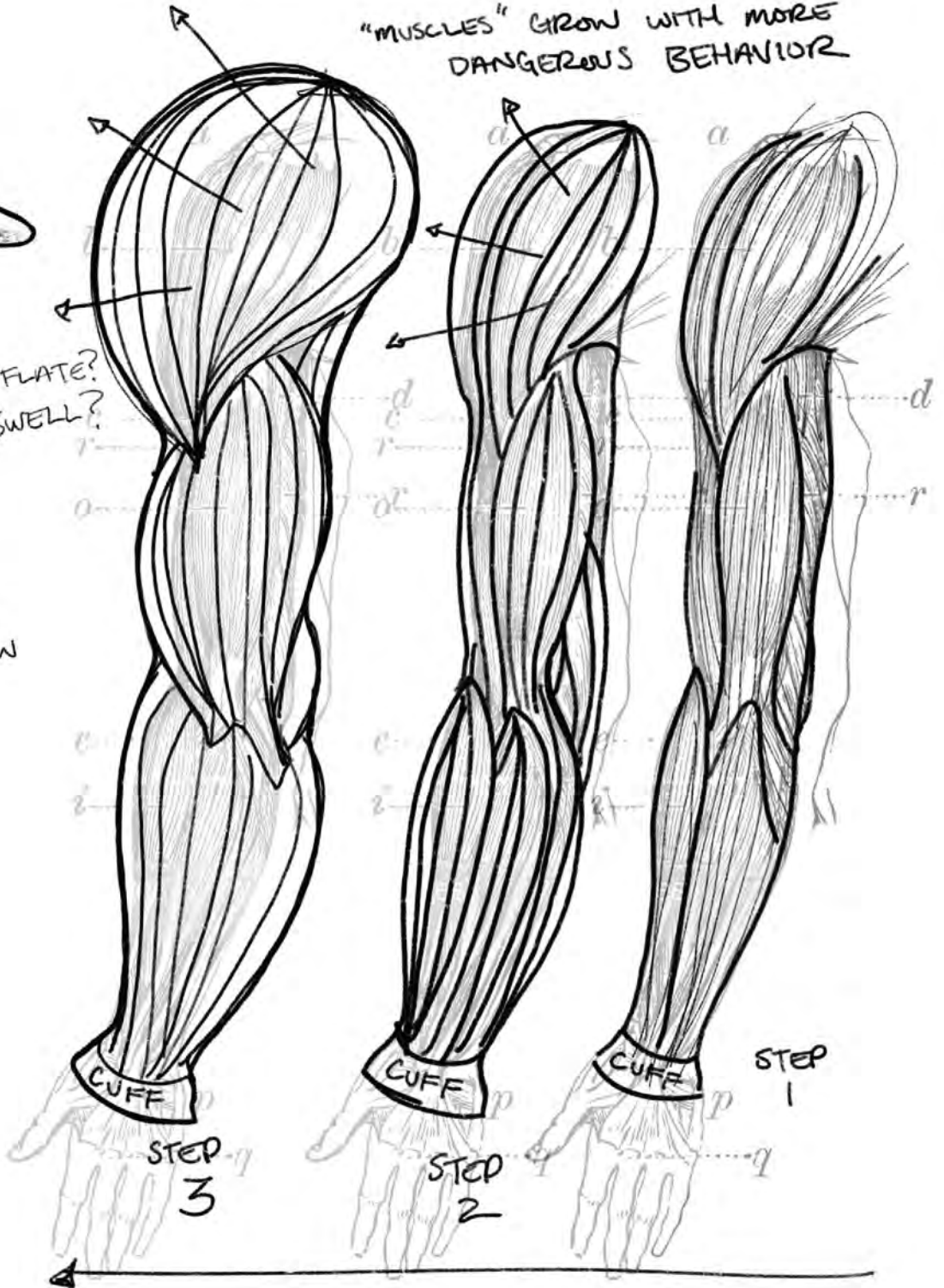

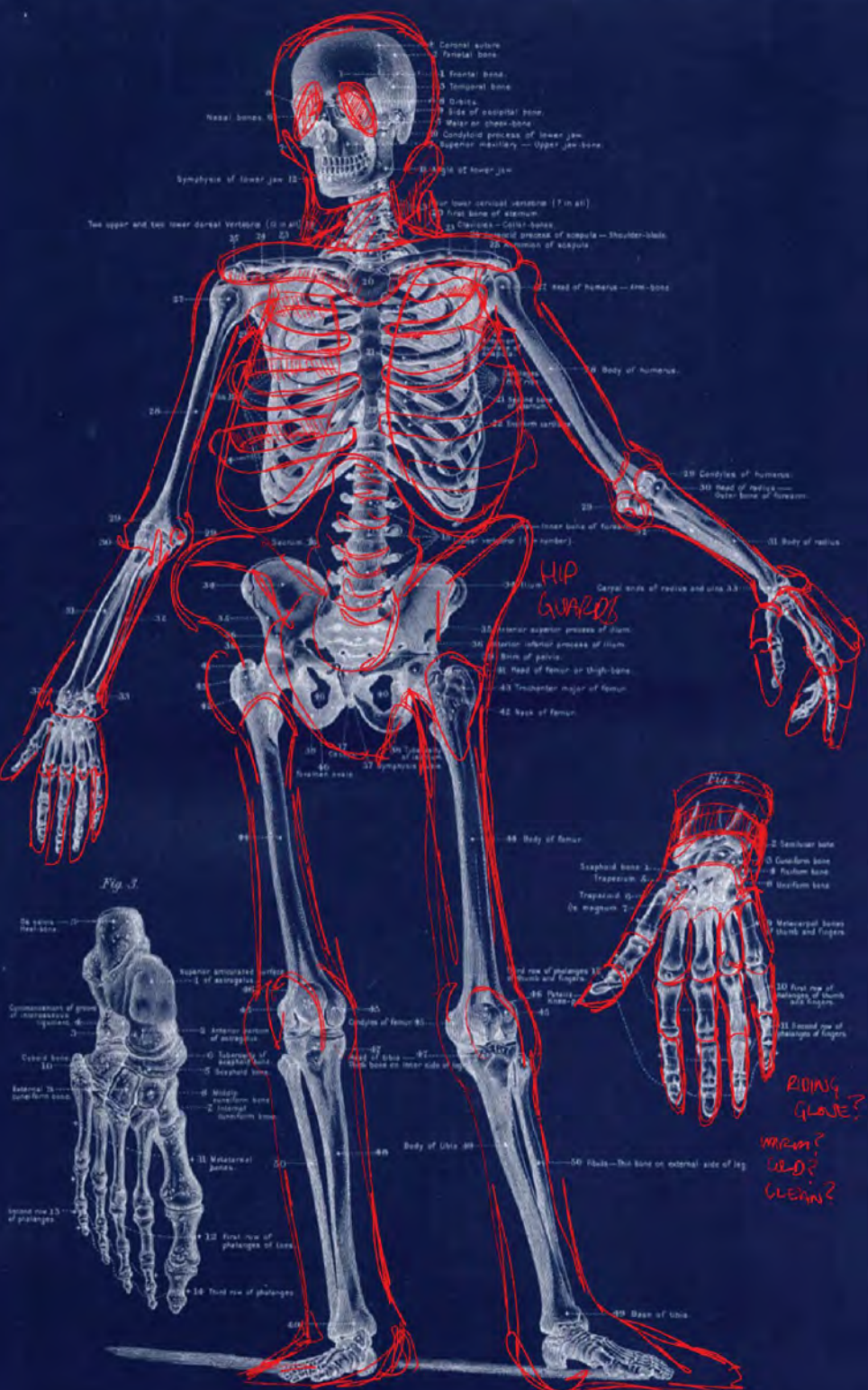

Human bone structure



Bird bone structure

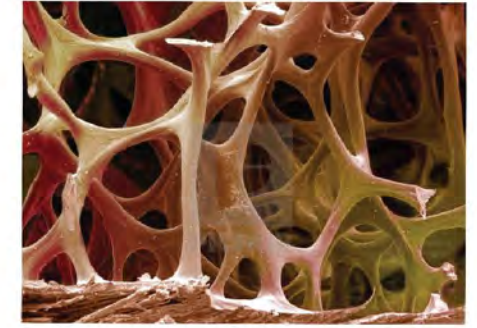

CAN WE MAKE YOU
LIGHTER?



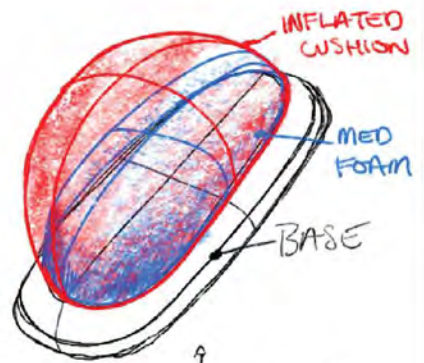
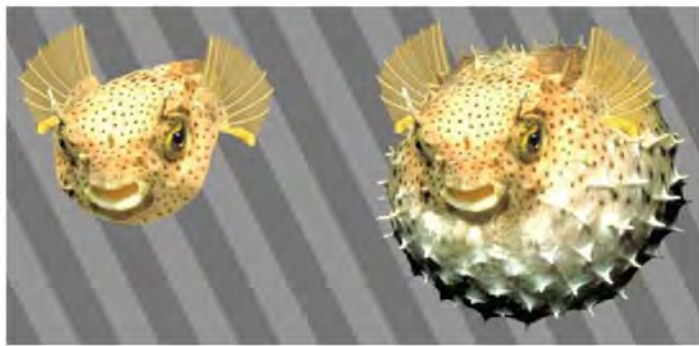

"I was inspired by wildlife that scares off predators (fear) by altering their body shape."

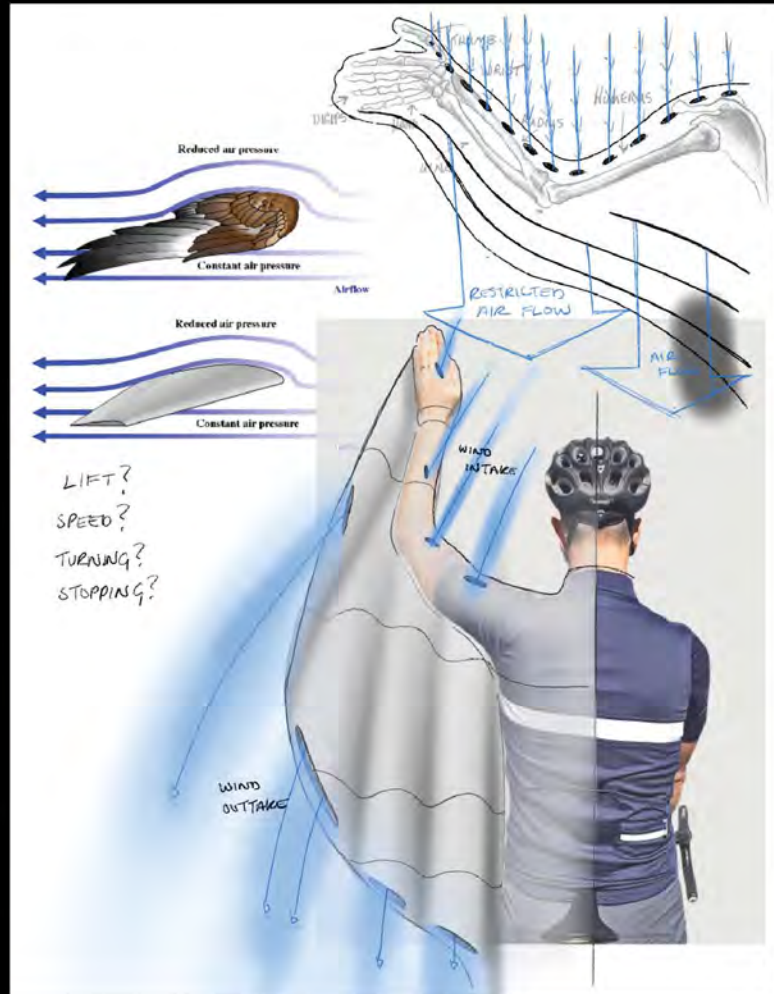
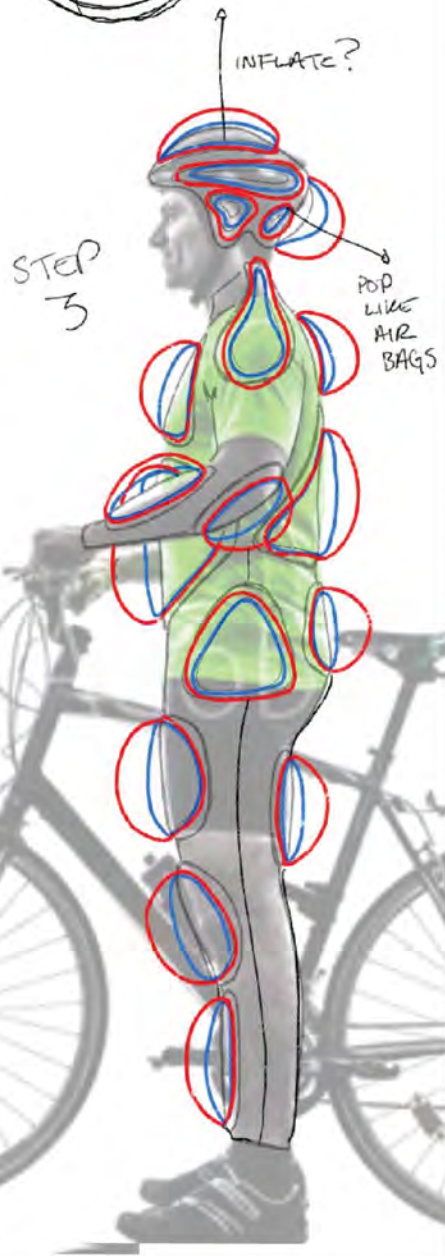

"The Blowfish inspired me to develop expandable and soft armor for falling."

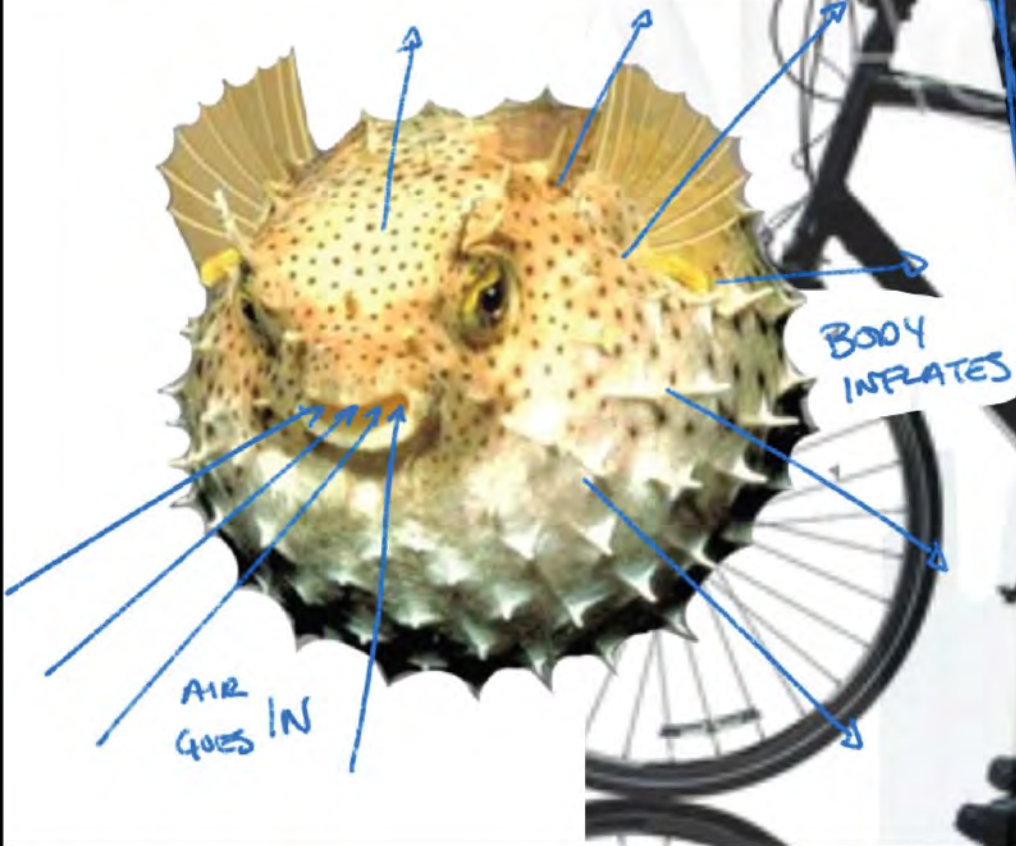
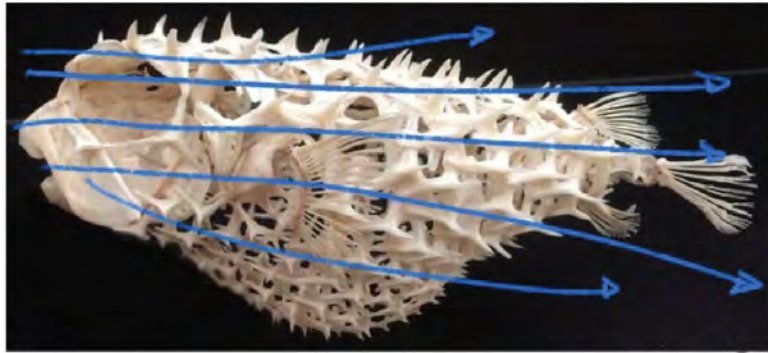

SPINE
PADDING

PARACHUTE?

WIND SLOW
DOWN
FALLS?

CAN AIR INFLUATE
A LARGE PAD OR
PARACHUTE?

NERVOUS SYSTEM

The nervous system, essentially the body's electrical wiring, is a complex collection of nerves and specialized cells known as neurons that transmit signals between different parts of the body. Vertebrates, animals with backbones and spinal columns, have central and peripheral nervous systems.

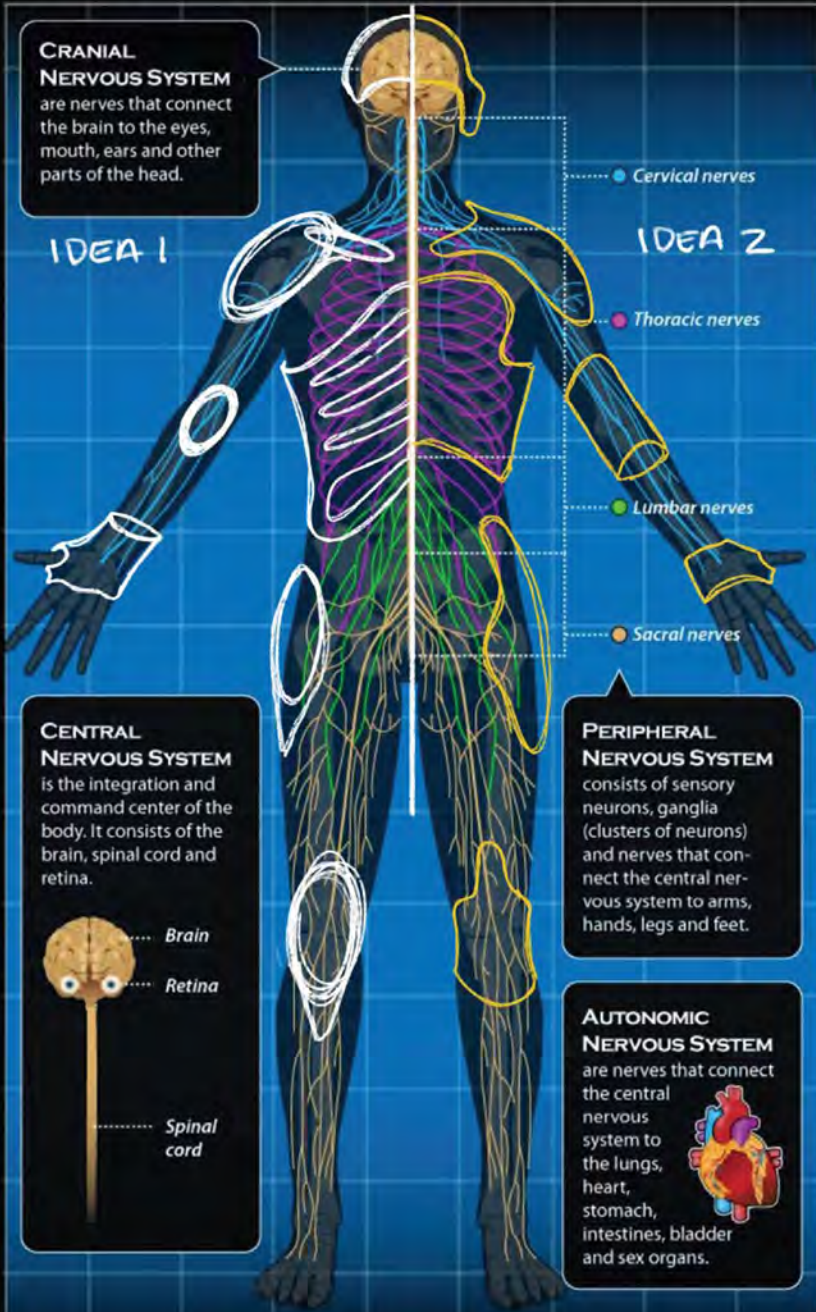

IDEA 1: A SYSTEM OF EXTERIOR SYSTEMS THAT REACT TO THE NERVOUS SYSTEM TO PROVIDE EXTRA SAFETY DURING TIMES OF DISTRESS

NERVOUS SYSTEM

The nervous system, essentially the body's electrical wiring, is a complex collection of nerves and specialized cells known as neurons that transmit signals between different parts of the body. Vertebrates, animals with backbones and spinal columns, have central and peripheral nervous systems.

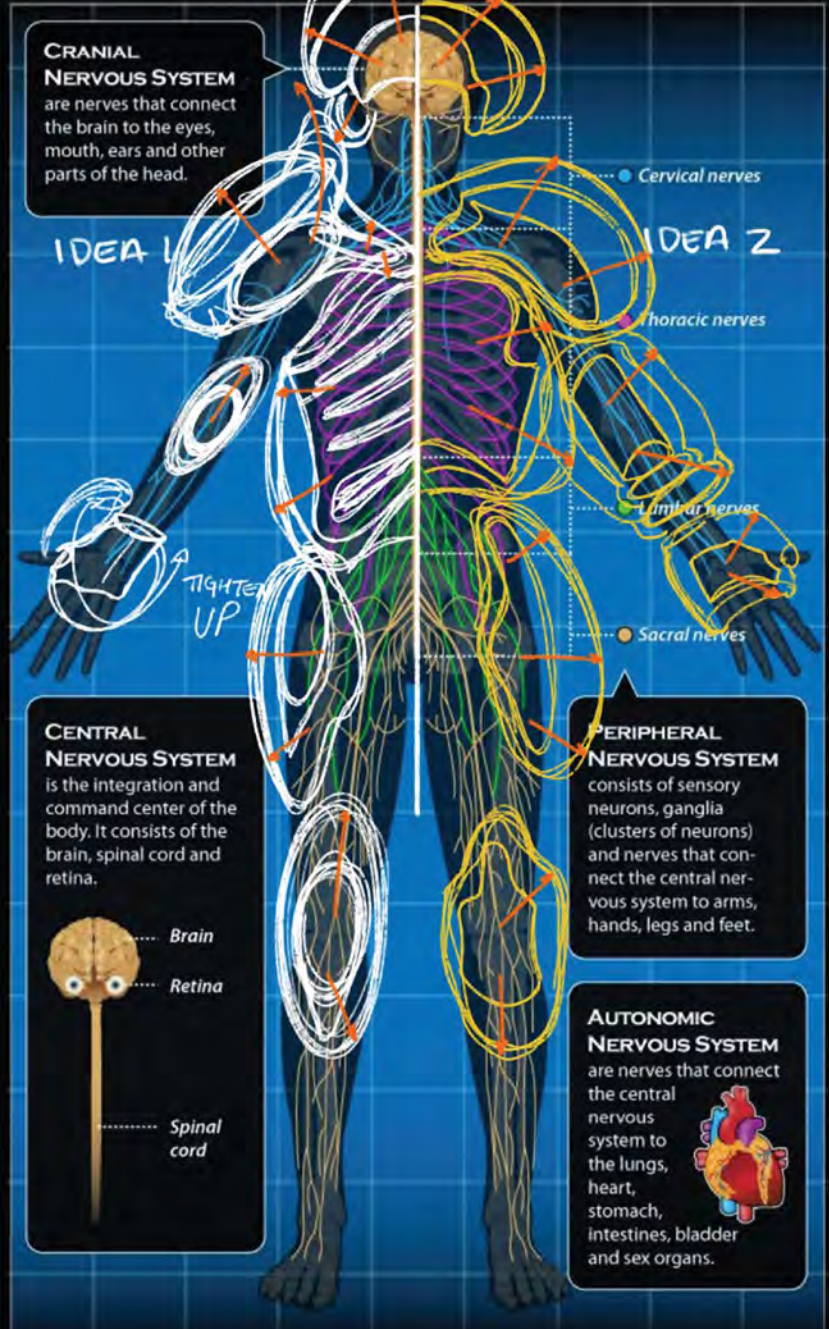

IDEA 2: PADDING THAT HARDENS AND SOFTENS ACCORDING TO THE STRESS LEVELS OF A RIDER.

“How about a type of ‘scale’ padding that would be breathable but also lock up when the user falls, just like a pangolin.”

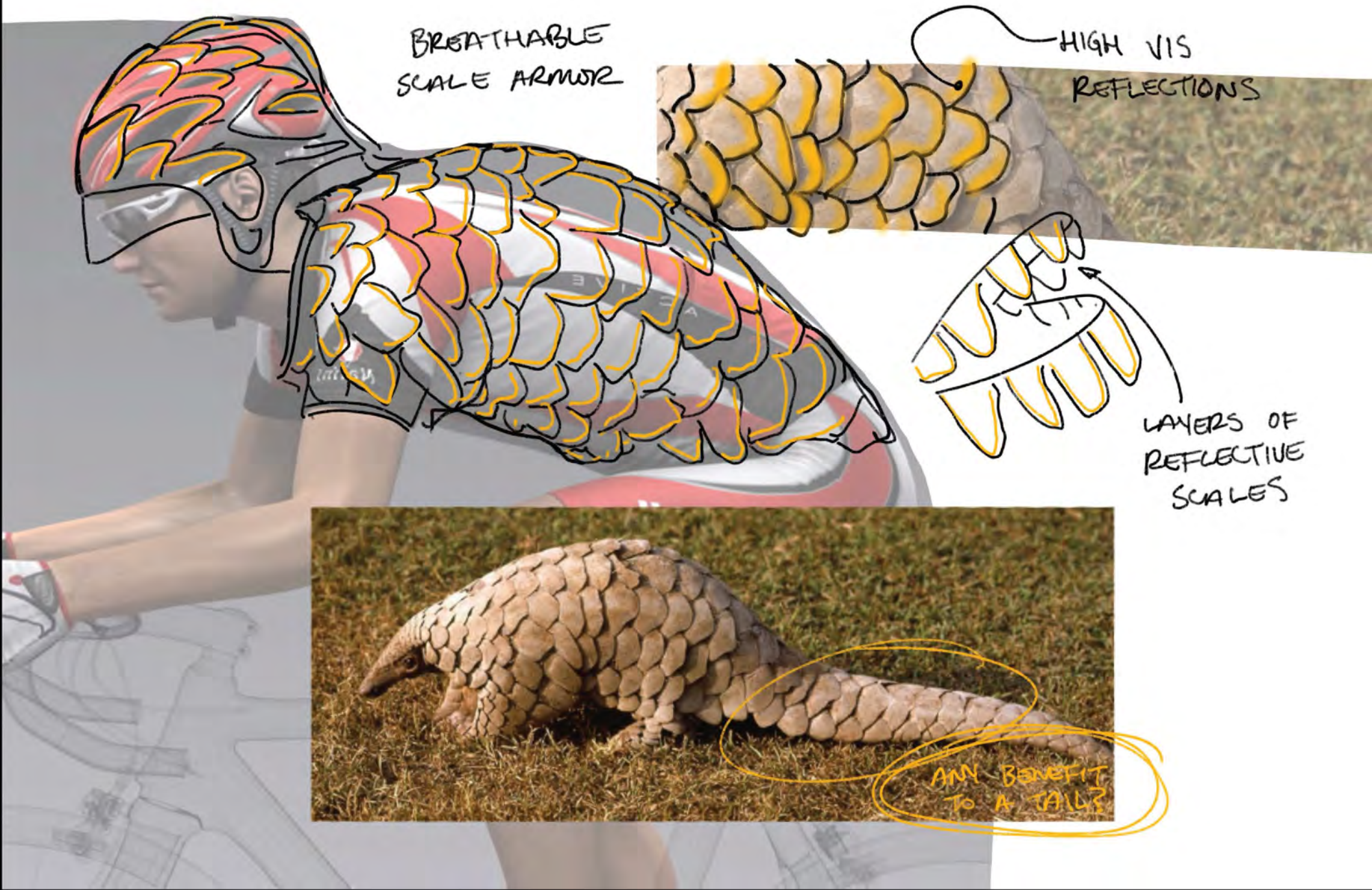

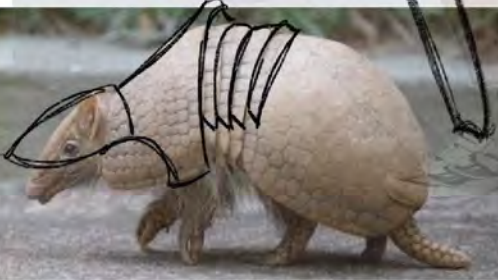
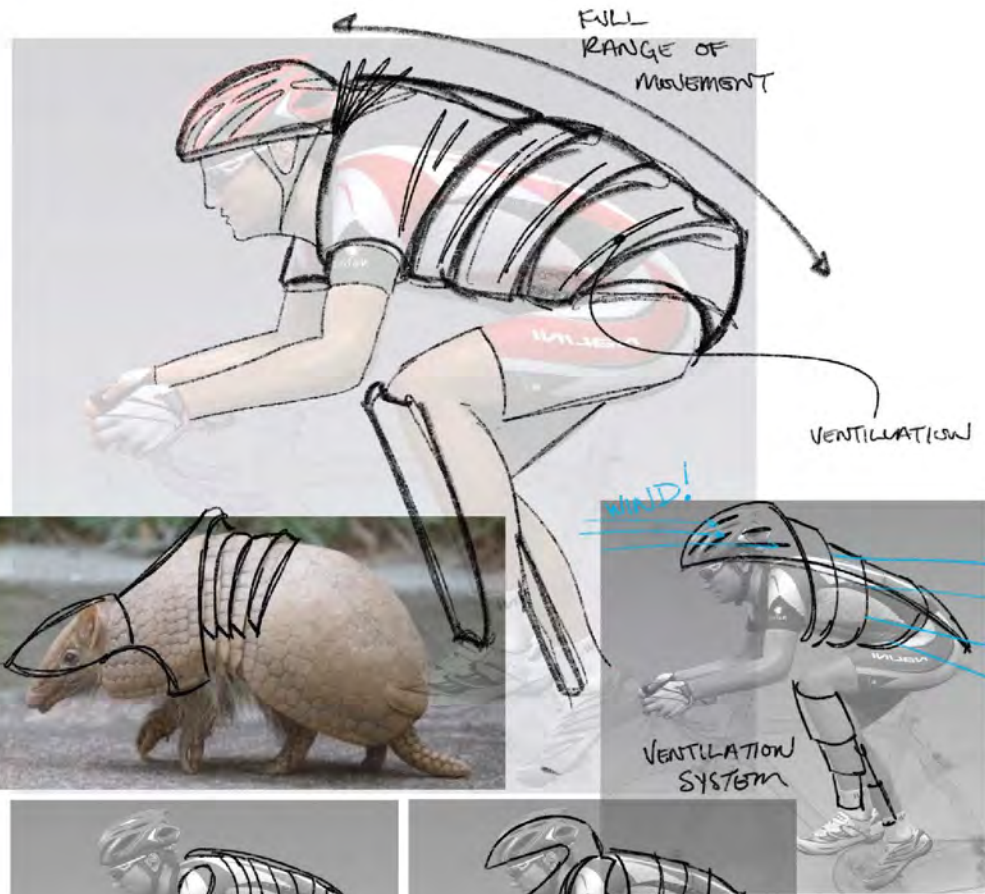
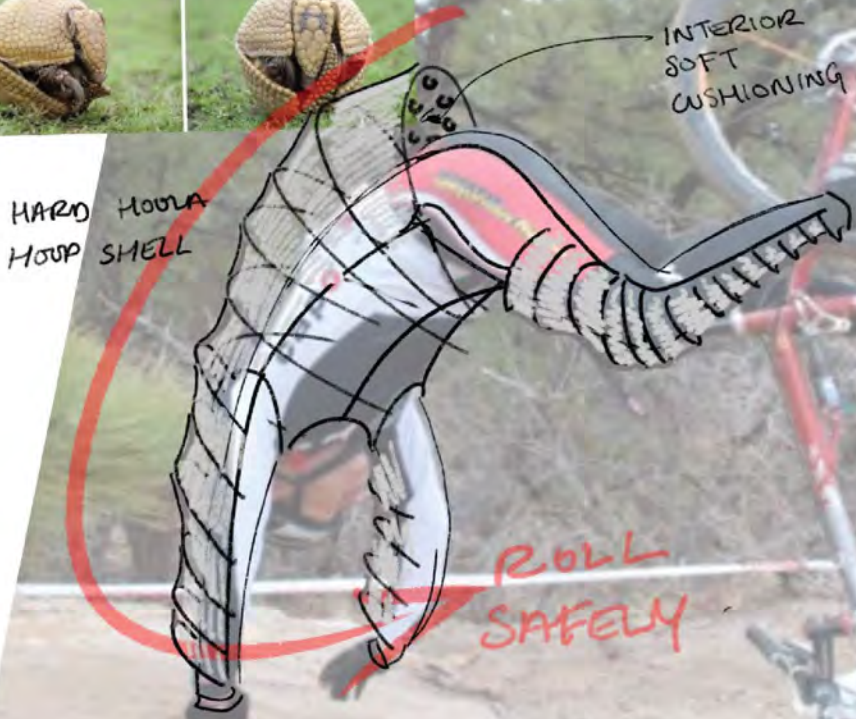

“Collapsible armor was a very early ideation that carried on throughout the entire project.”

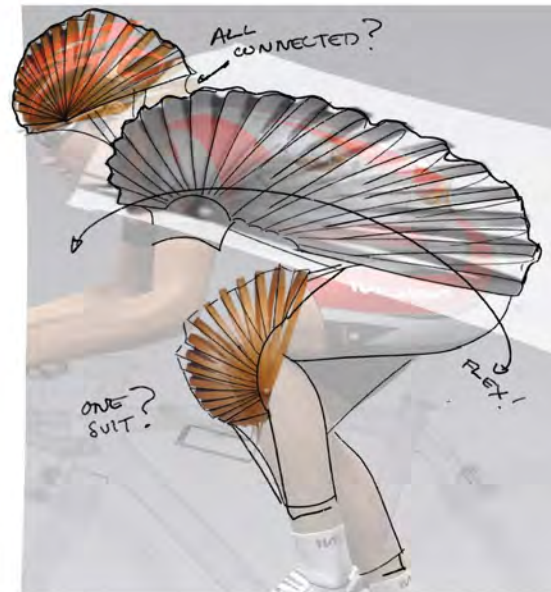
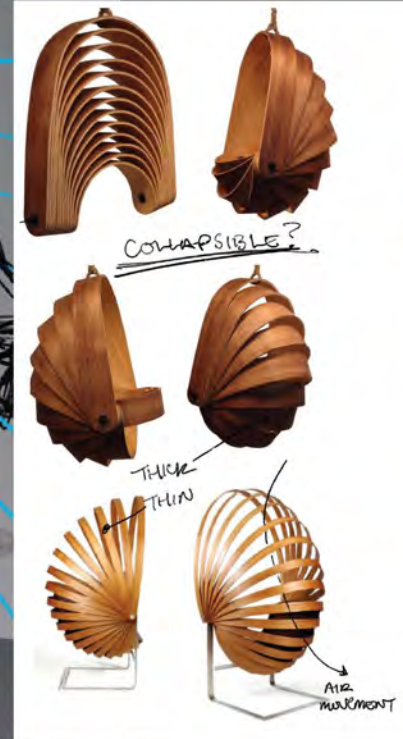
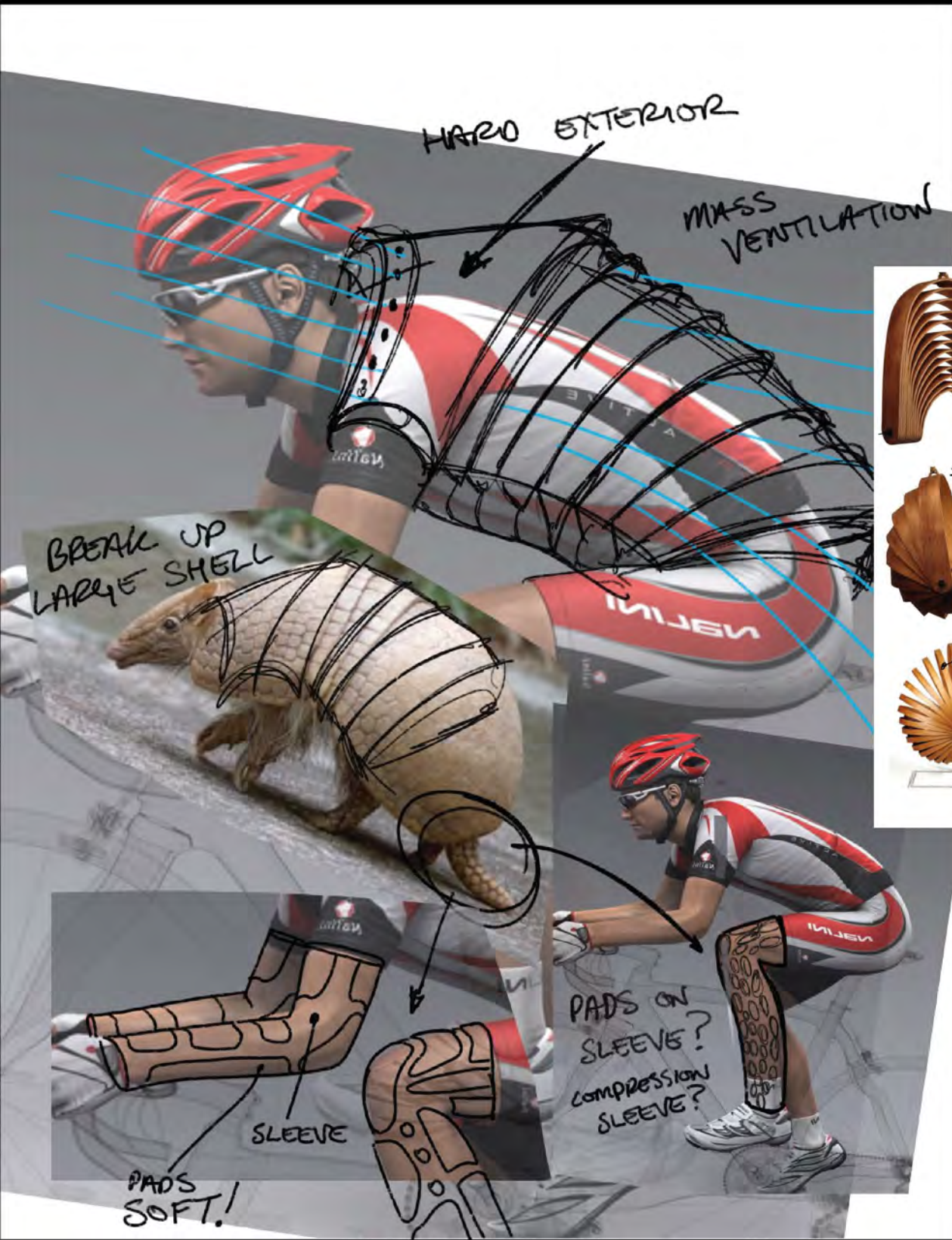

“How do we roll, how do we fall, and how do we get hurt?”

Shake or Slap for light.

Tuck it in.

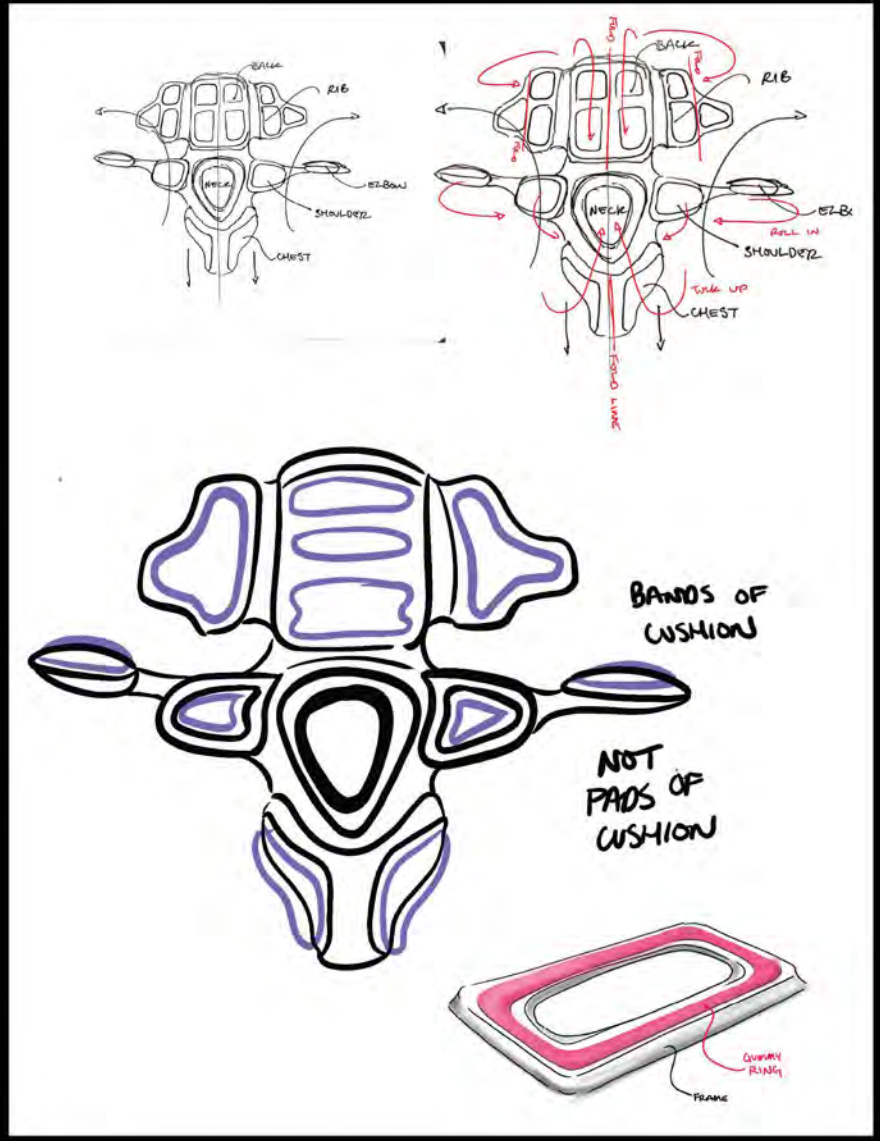
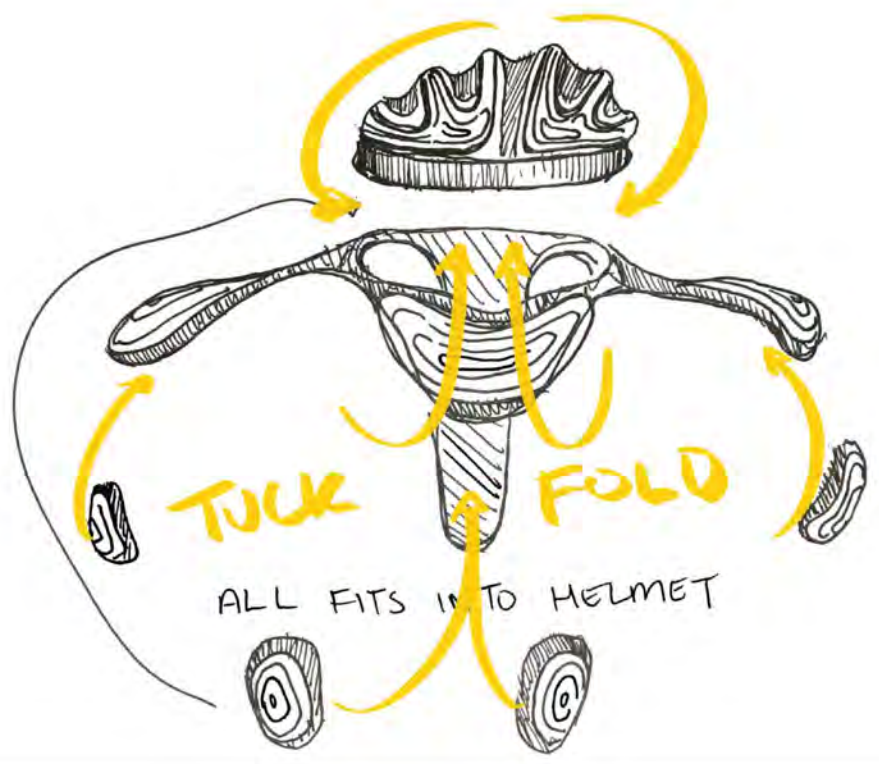
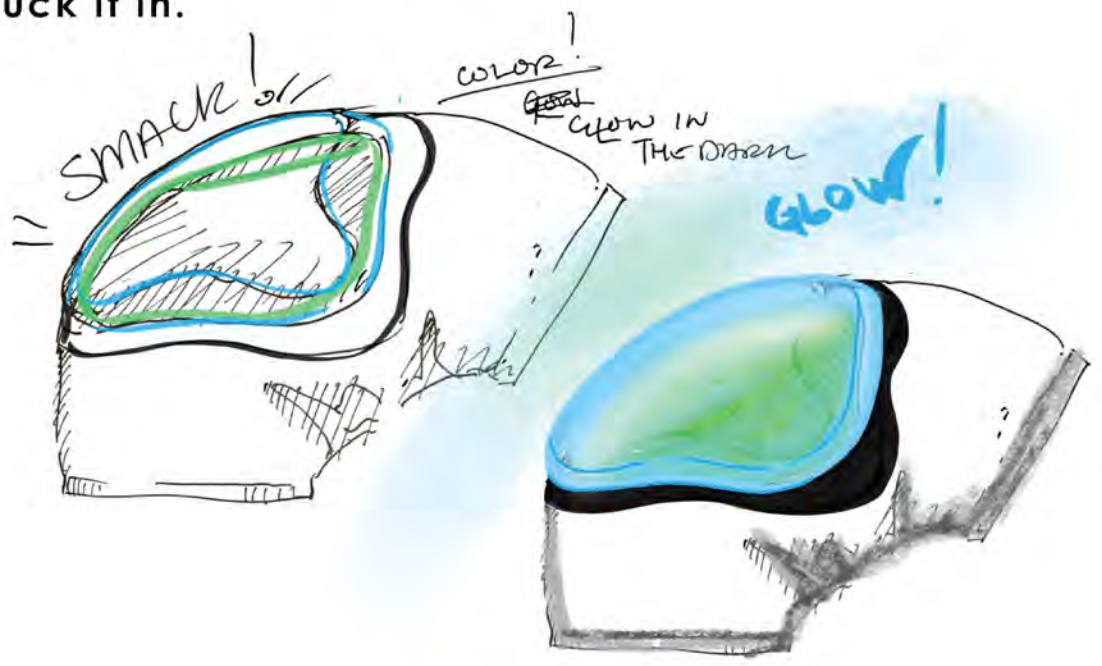

“A glowing aspect of the project also started early on in the ideation process. Either like a glowstick or reflective when light hits it.”

A series of mats with expanding foam on them?

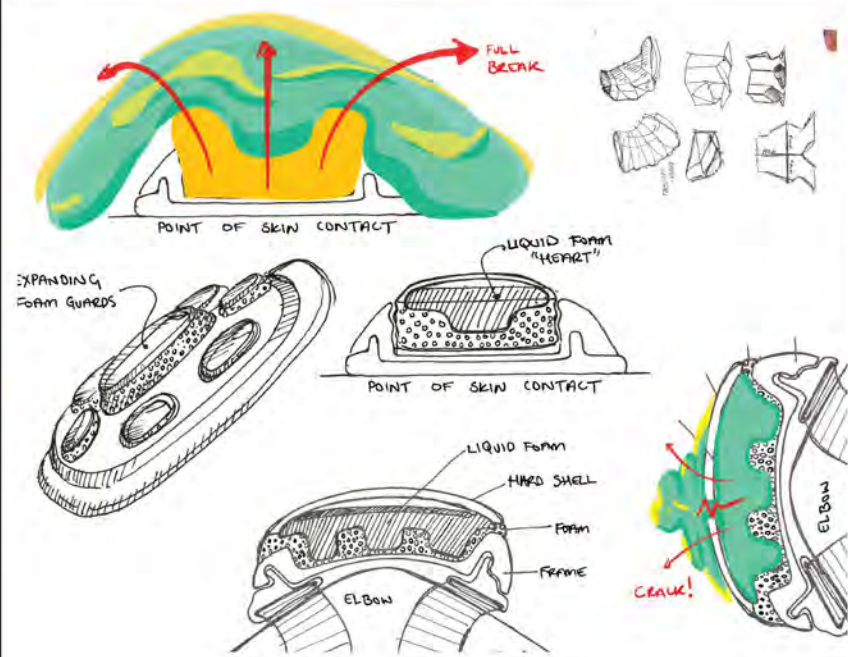
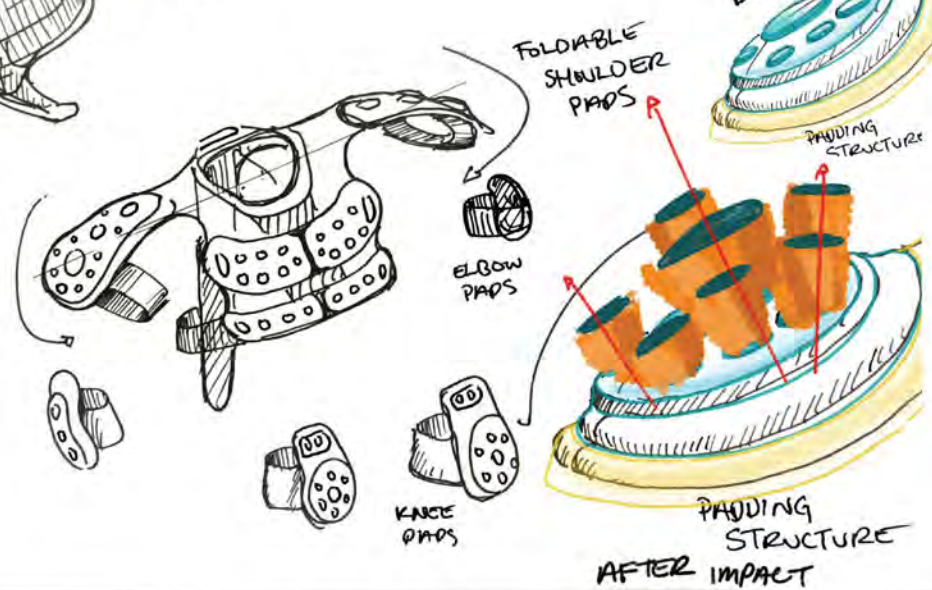
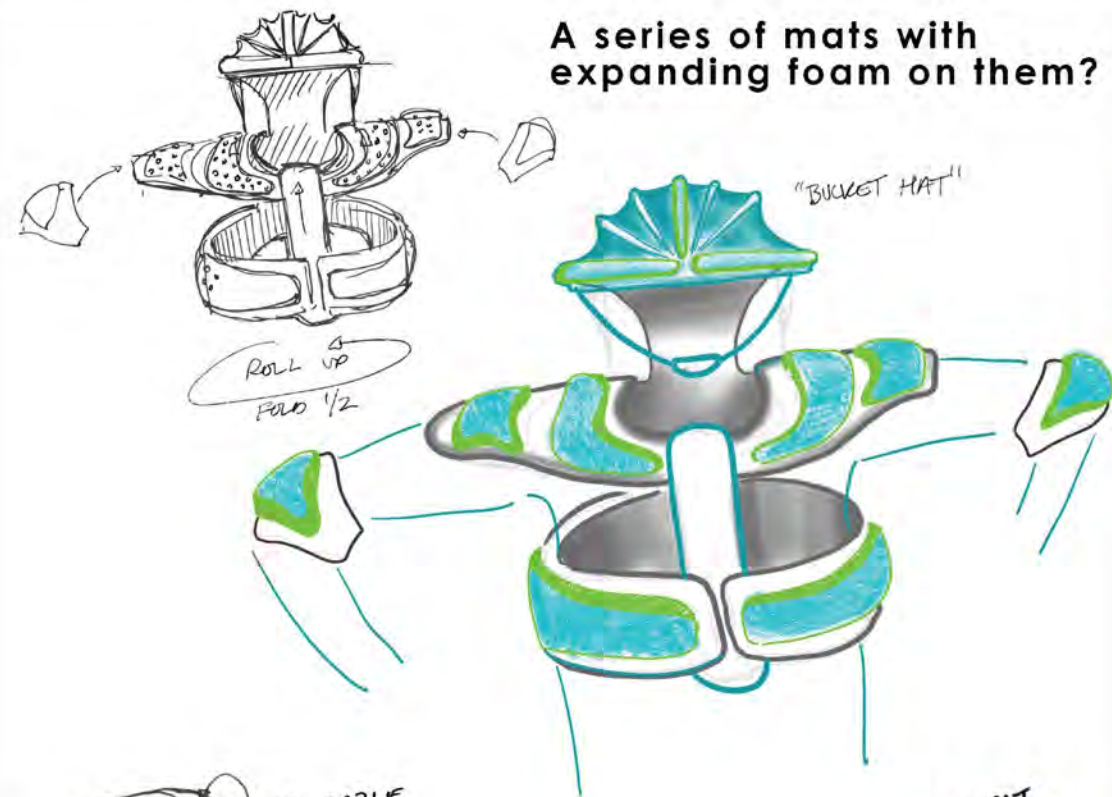

Biodegradable and safe.
 Sticky.
 Fast acting when introduced
 to oxygen.
 Maybe it's even fertilizer or seed.
 It's for bad situations.

“Once a biker falls, is there a way that we slow them down faster? Can they stick to the ground to prevent sliding? How could we use expandable foam to help us stick to the ground and prevent us from any injuries?”

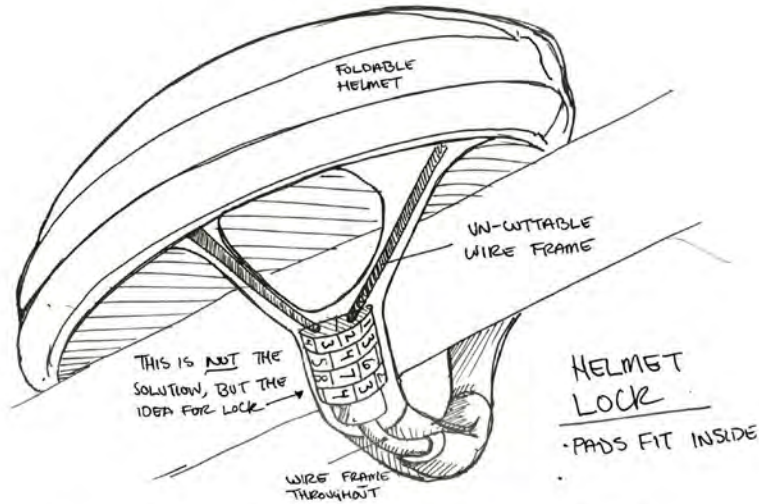
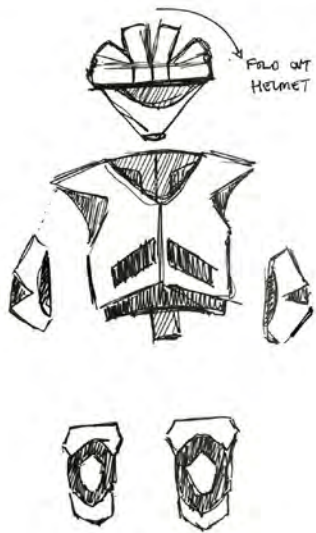

If everything fits in the helmet, can the helmet's frame be used as a bike lock?
 No excuses for not wear pads.

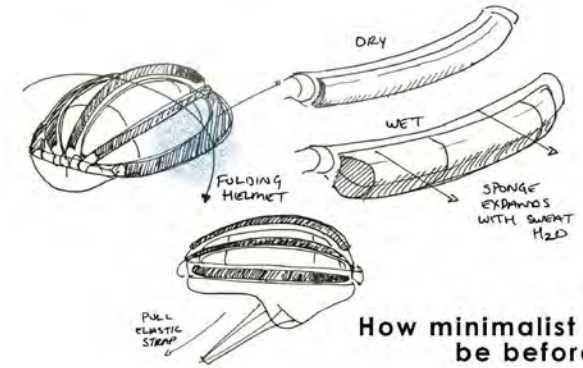

How minimalist can a helmet be before it's useless?

How small can the skeleton be?

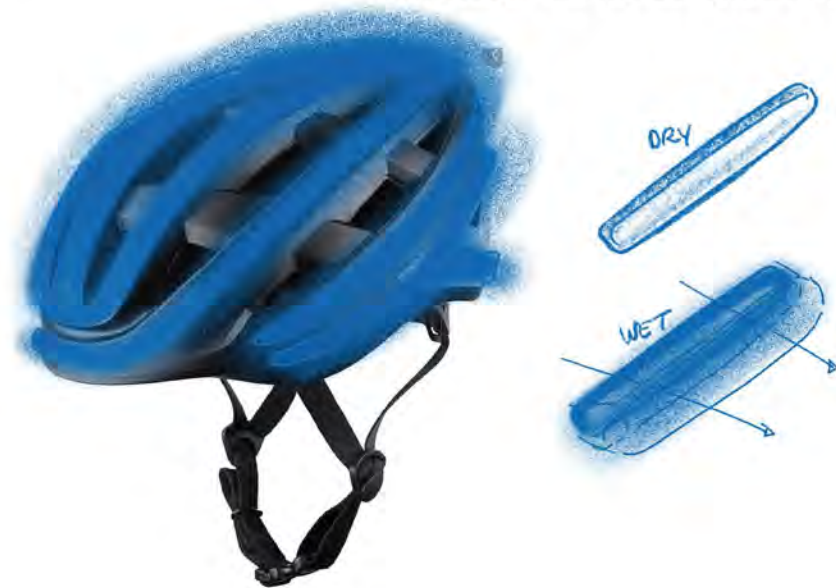
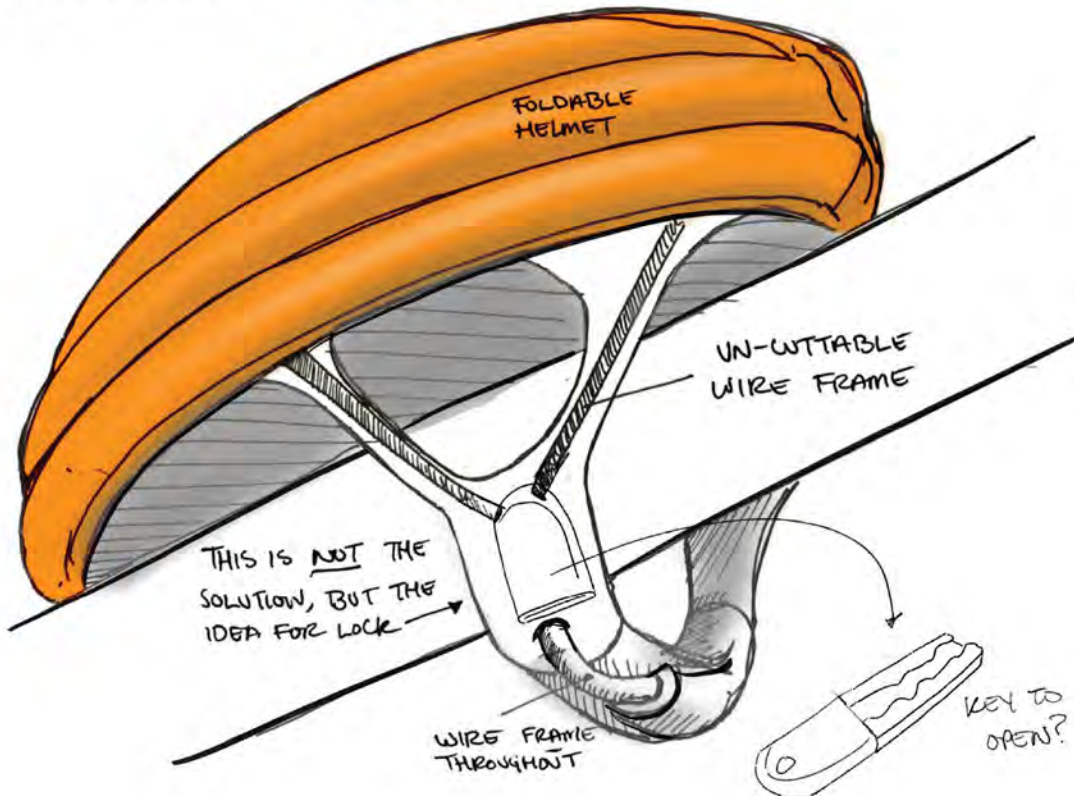

Inflatable or expanding helmets.
 A hard shell on top of a soft expanding cushion.
 All pads inflattable?

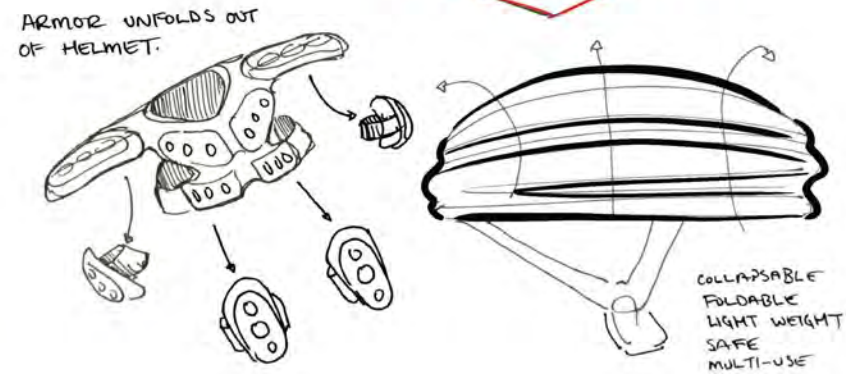
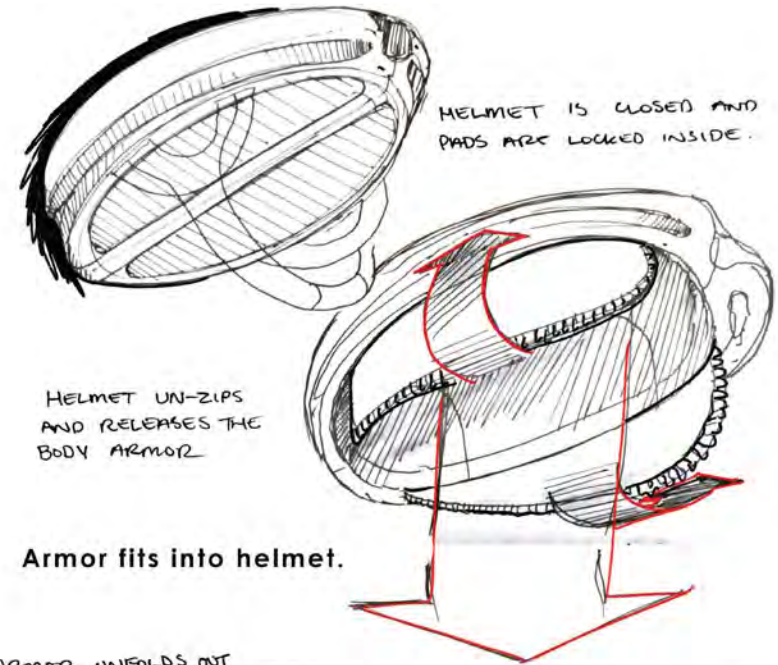
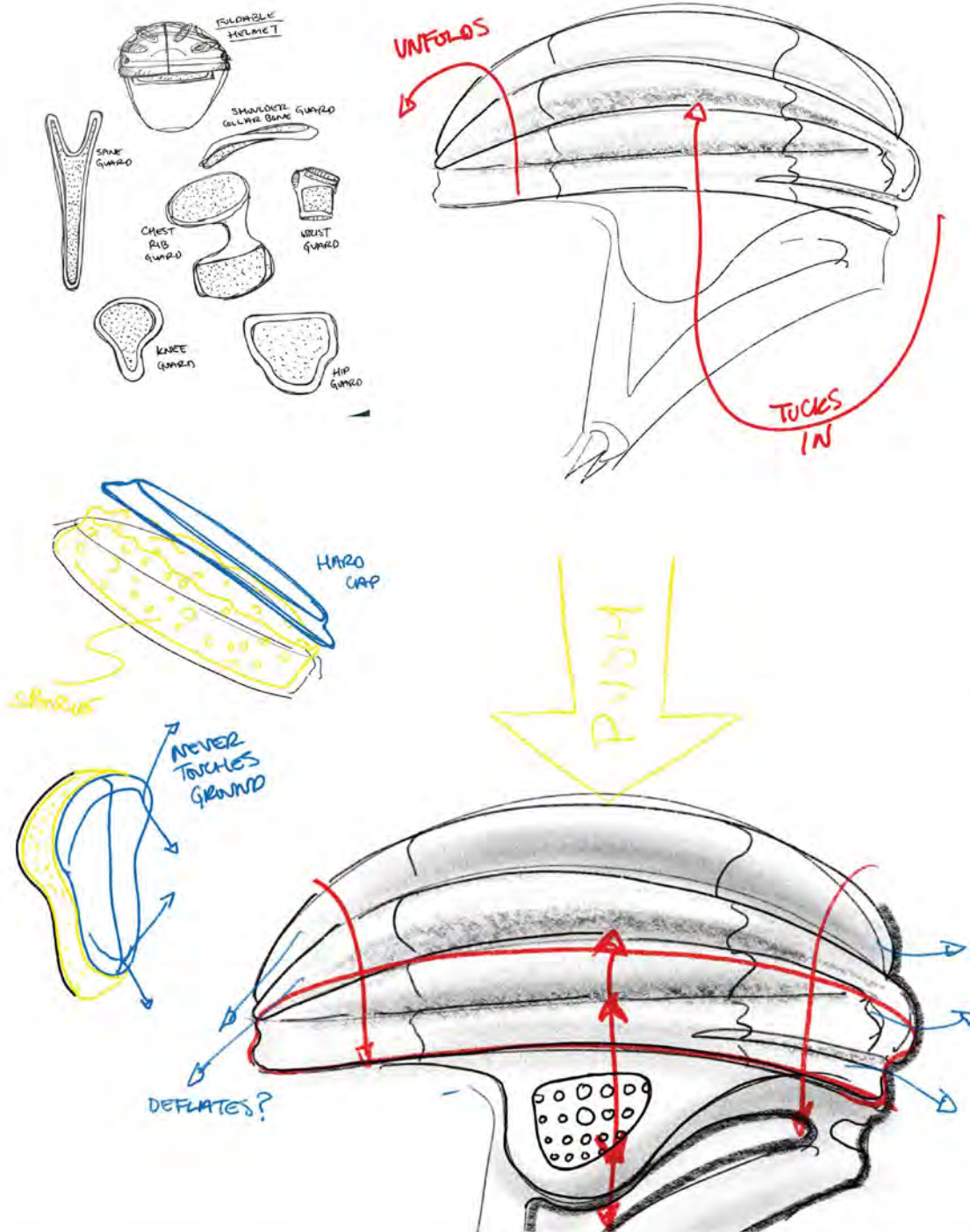

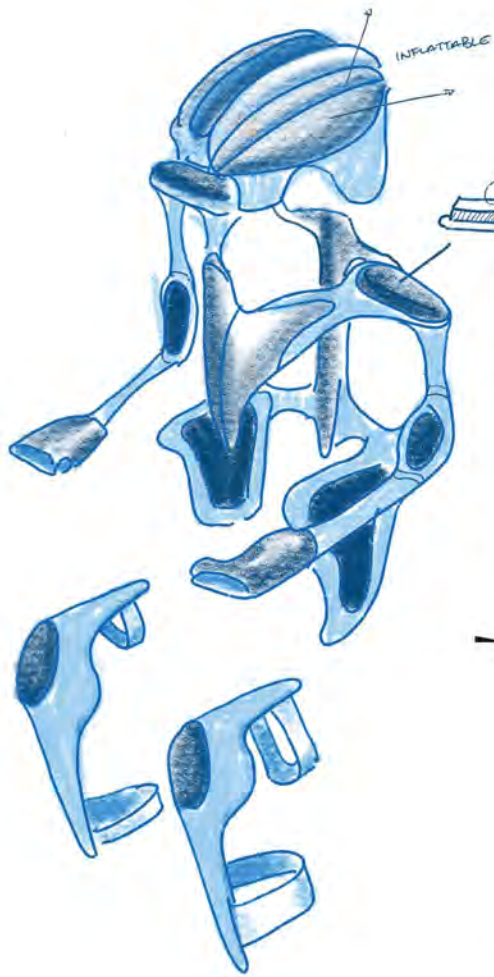

RABBIT IN THE HAT

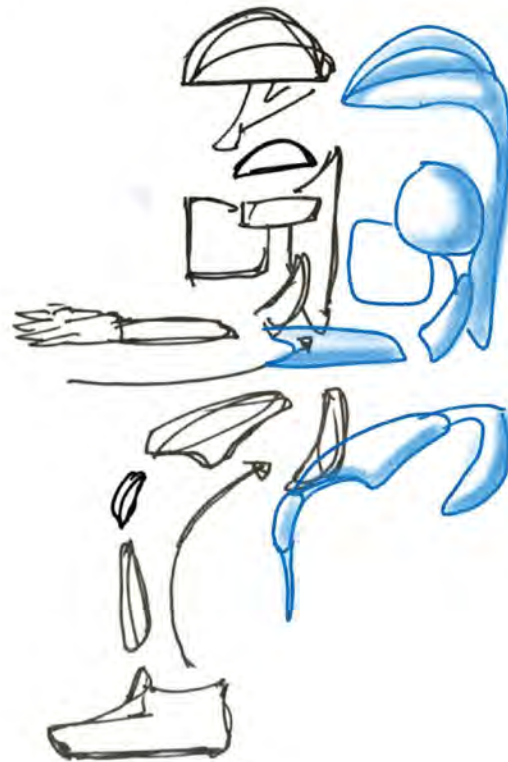
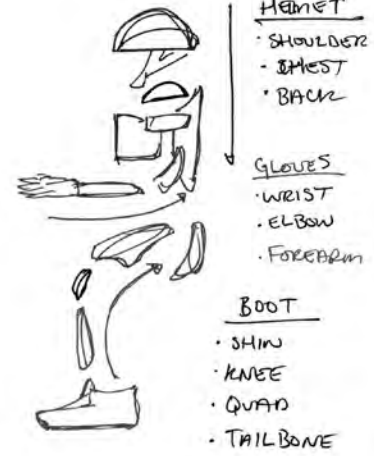
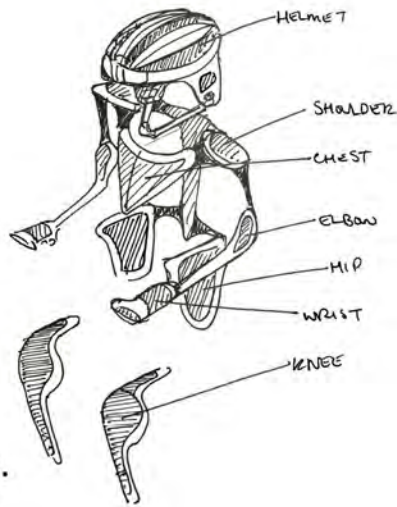
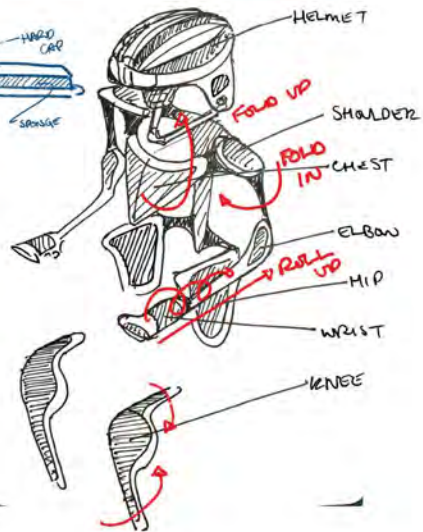

More like stickers or a blister that is applied and fastened with straps. Jelly pads.

Can it unfold like a map to a new world?

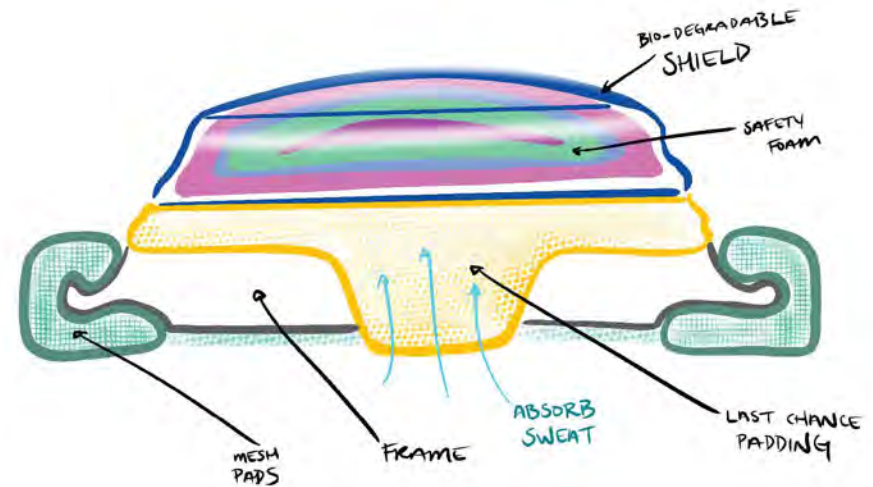
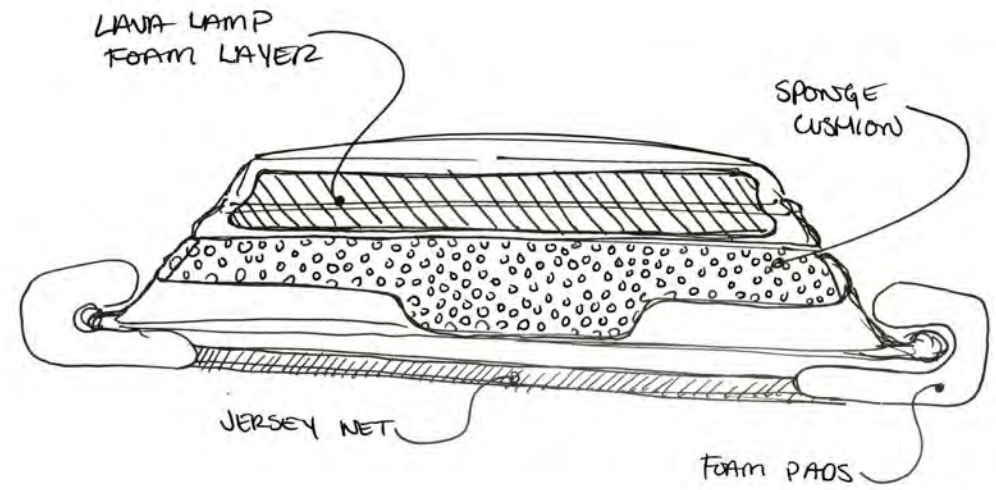
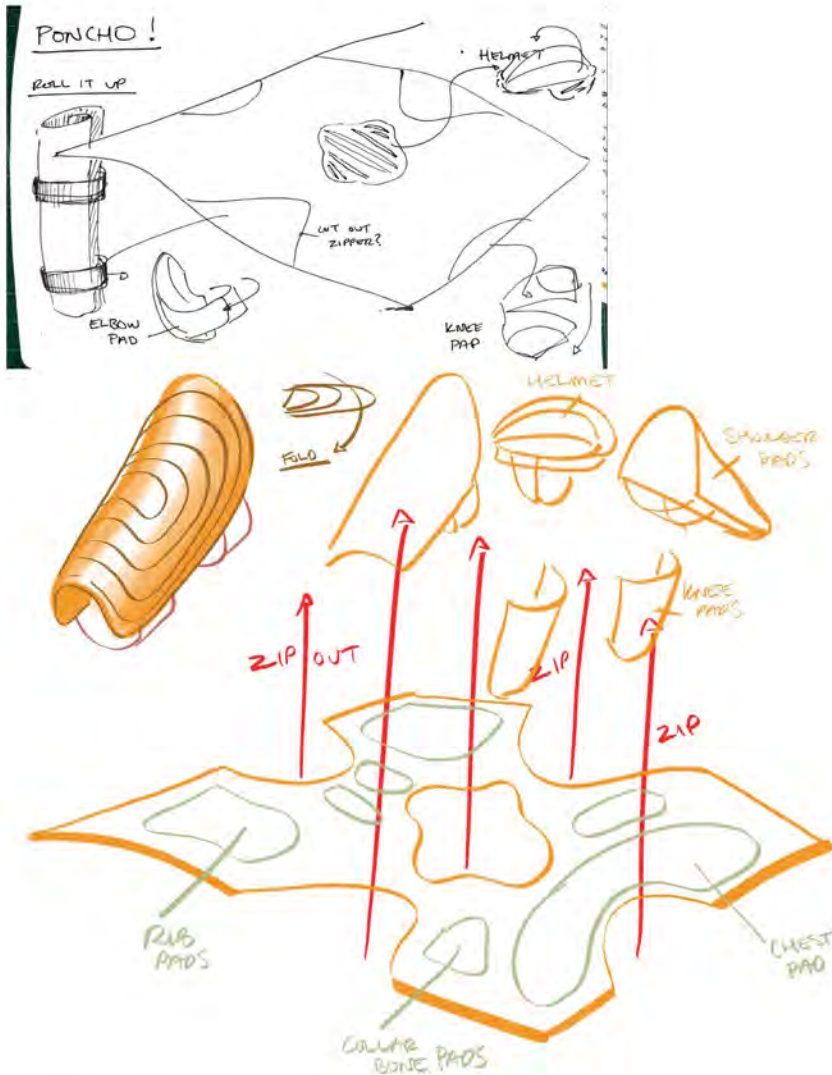

Can it be worn by the world?
 The idea is that it's a one roll mat/pad that has the different joint pads and helmet zipped in. Like a yoga mat for your armor.

A cross section view of the padding layers. Last Chance Padding absorbs sweat and grows for heavier protection. Inside is chemistry mixture that produces foam with exposure to oxygen.

WEEK 8 MIDTERM

“We had to present three separate proposals and our ideation on how to execute the designs.

There was also a fine art piece to represent our story.”



FLEX UP

FLEX UP



READ SWEAT BACTERIA INFO

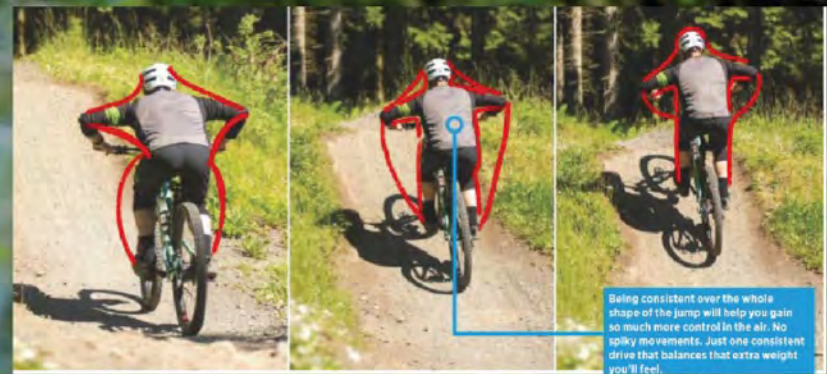

Being consistent over the whole shape of the jump will help you gain so much more control in the air. No spiky movements. Just one consistent drive that balances that extra weight you'll feel.



Being consistent over the whole shape of the jump will help you gain so much more control in the air. No spiky movements. Just one consistent drive that balances that extra weight you'll feel.

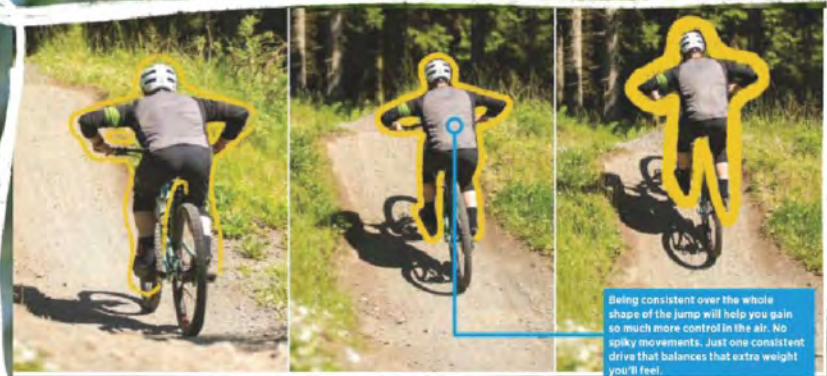

Being consistent over the whole shape of the jump will help you gain so much more control in the air. No spiky movements. Just one consistent drive that balances that extra weight you'll feel.

!!! HOW CAN A SOFT SHIELD DETECT FEAR AND BECOME HARD?

ORIGAMI ARMOR

REACTIVE LIGHT WEIGHT
STACKABLE FLEXIBLE



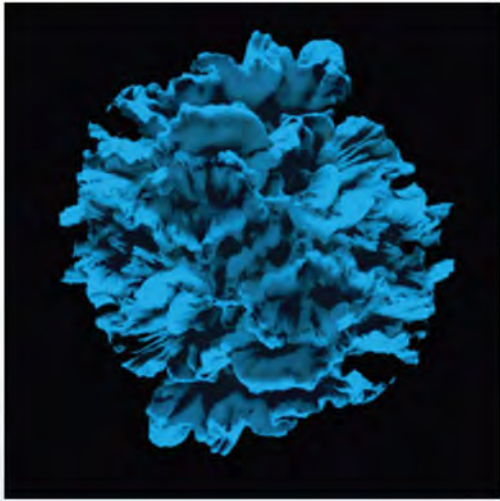

FOAM CLOUDS
EXPANDABLE LIGHT
BREATHABLE SPONGE
BOUNCY



SLIME ARMOR
LIGHT EXPANDING FOAM
STICKY PREVENTS SLIDES

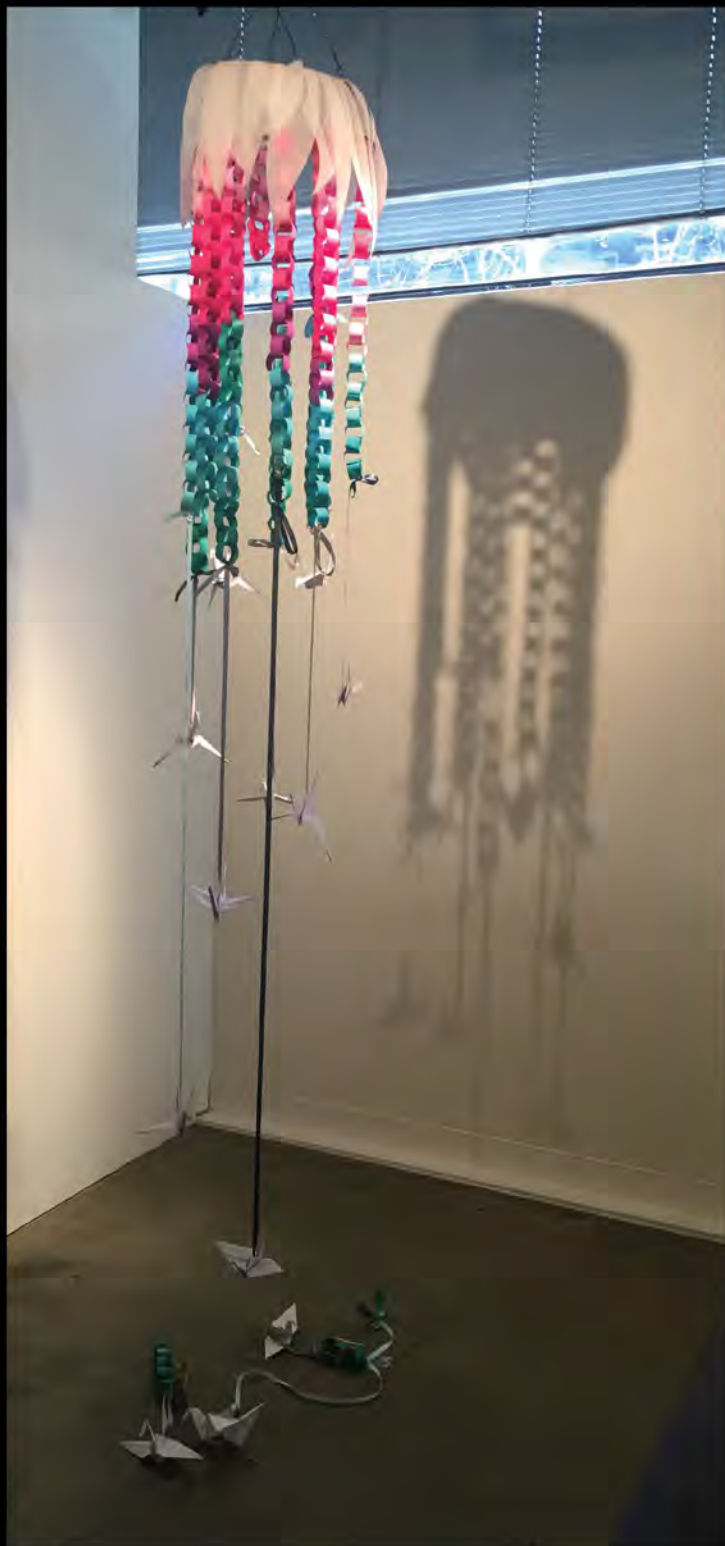

THE FREEDOM HALO

“The fine art piece represents the story and intentions for the final design. The paper cranes represent the user, while the chains are representing detention or being grounded at home without your freedom.

The cranes want to fly free in the ‘freedom halo’ of the Specialized brand. Break the chains of oppression and fly free with Specialized.

Fly to your freedom.”

WEEK 9

KEY SKETCH LEAF IDEATION COVID19 STORY

“At this point in the term the COVID19 epidemic had hit, but school carried on.

LEAF was the design direction I wanted to pursue, but the story changed slightly.”

WEEK 10

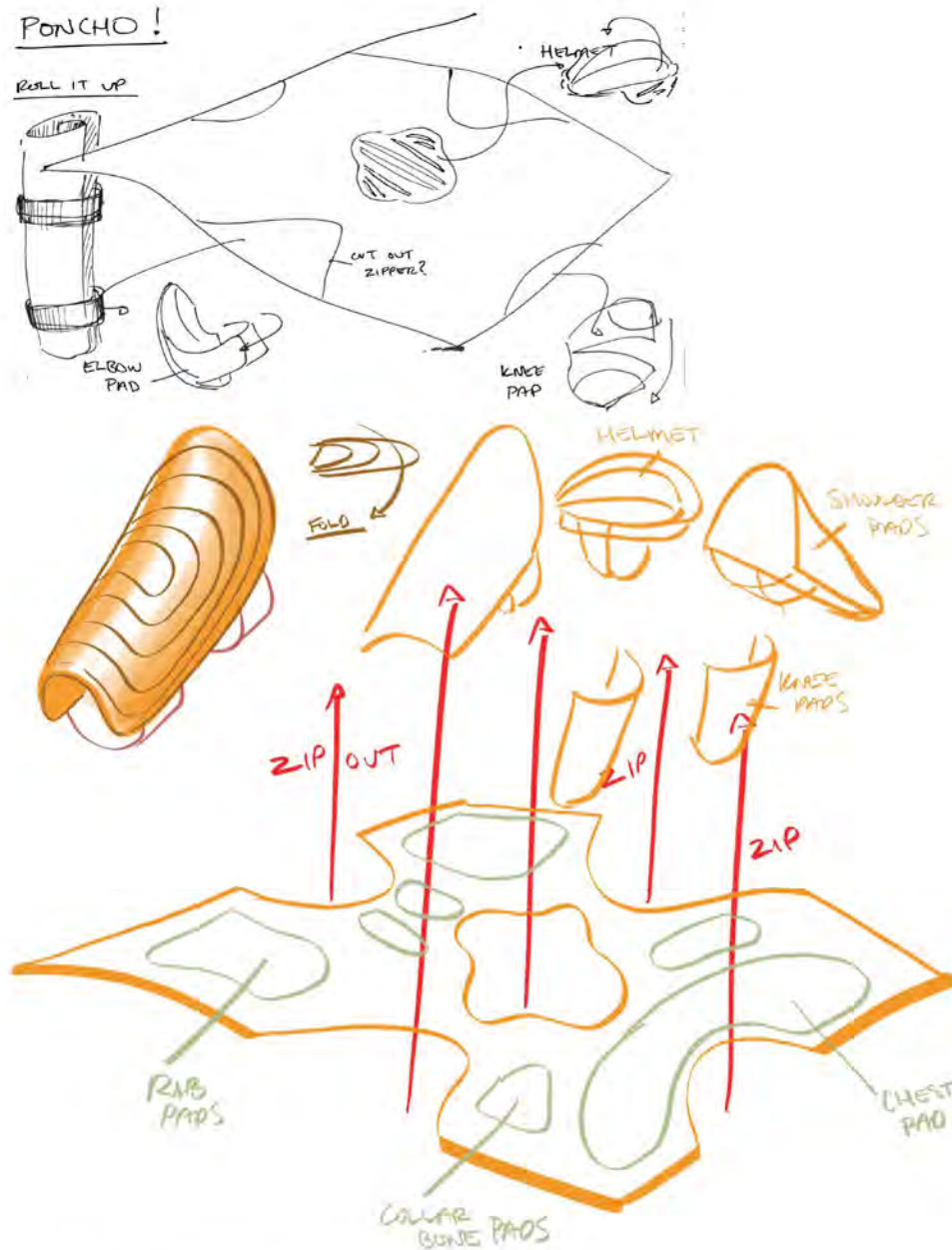

Can it be worn by the world?
 The idea is that it's a one roll mat/pad that has the different joint pads and helmet zipped in. Like a yoga mat for your armor.

Key Sketch

"This is where **LEAF** was born.

I was thinking about my environment, which is the **Summer Solstice**, the hottest day of the summer.

If you were just an animal in the wild, what would you use to shade yourself from the sun?

A LEAF."

Body shape

Does it have to be a square?

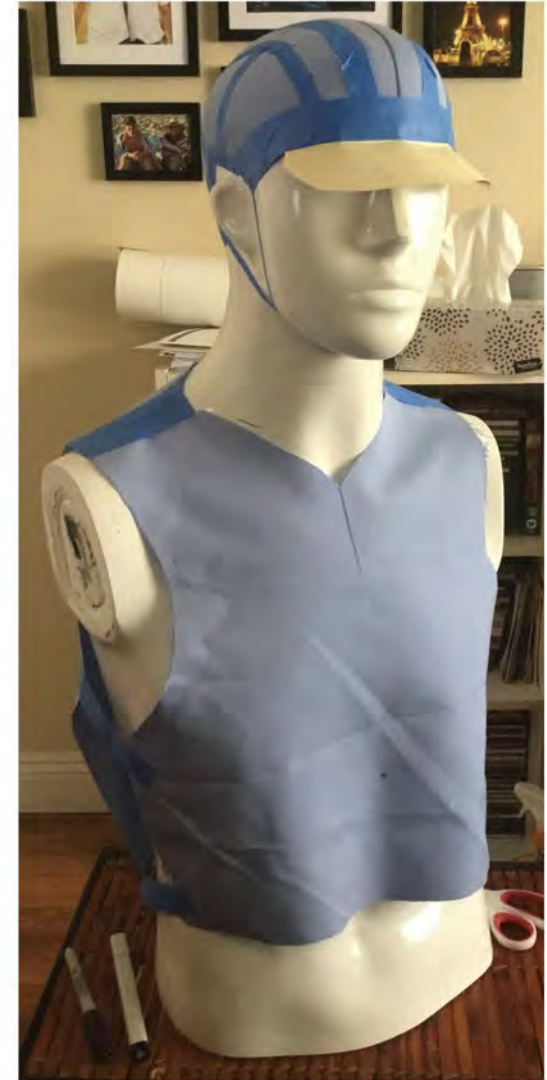

“I had to make an at home mock-up to wrap my mind around the dimensions and rough fit of what the key sketch was proposing.”

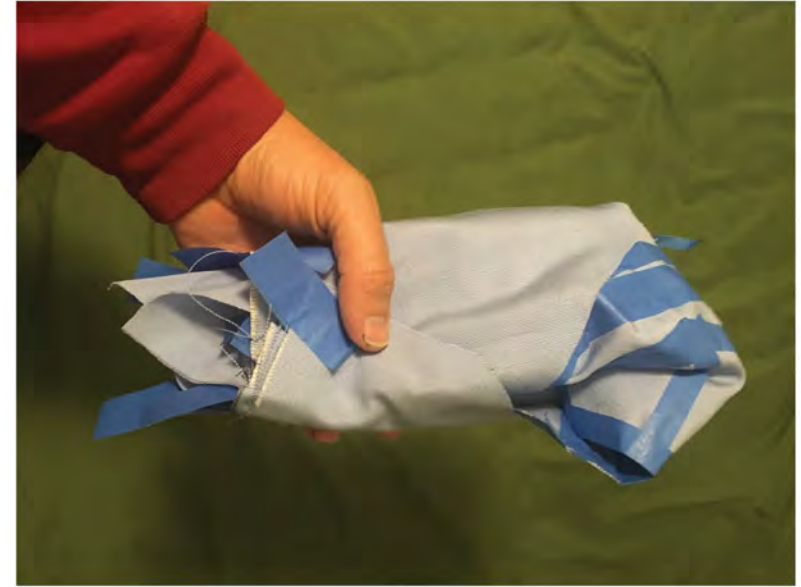
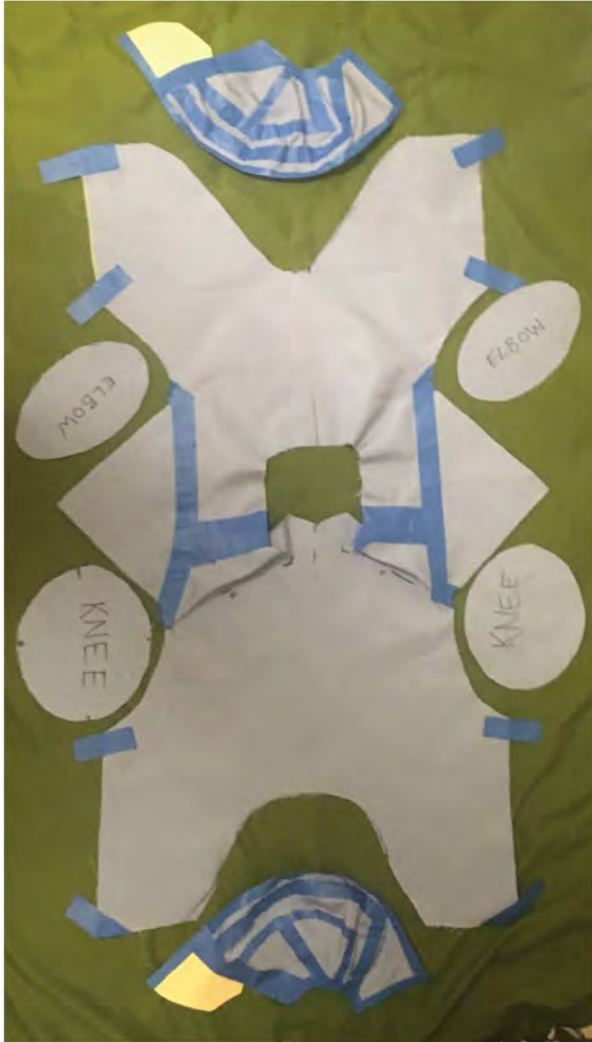

Mock-Up Tuck and Roll

Finishing all the different components of the mock-up helped me ideate and think about the spacing of the LEAF PADS.

Tracing the Leaf

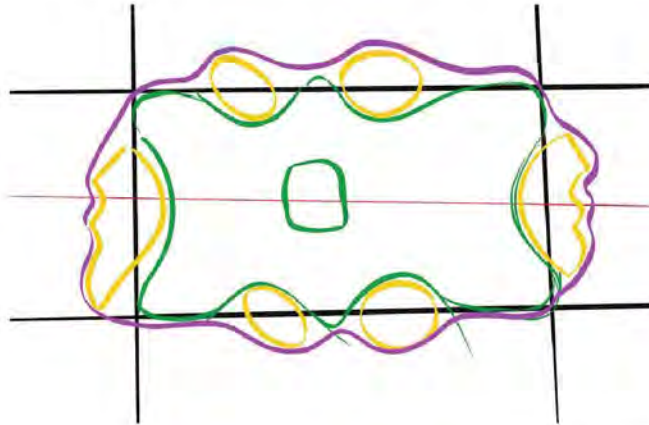

Since I had the spacing of the mock-up to rely on, I was able to trace and make up the LEAF as a whole.

All parts of the LEAF, including the SEED, use a male and female channel lock.

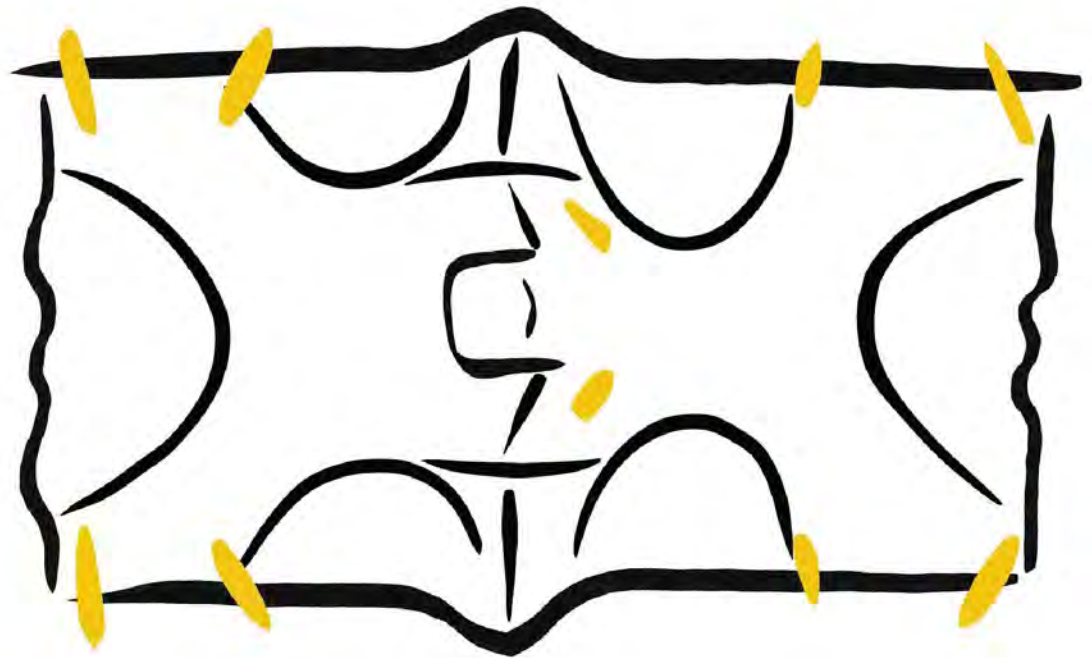

Where do the pads go?



“Flexible, glow in the dark, glow stick, foam, Tron-like padding was part of the ideation here.”

Seed Helmet Design

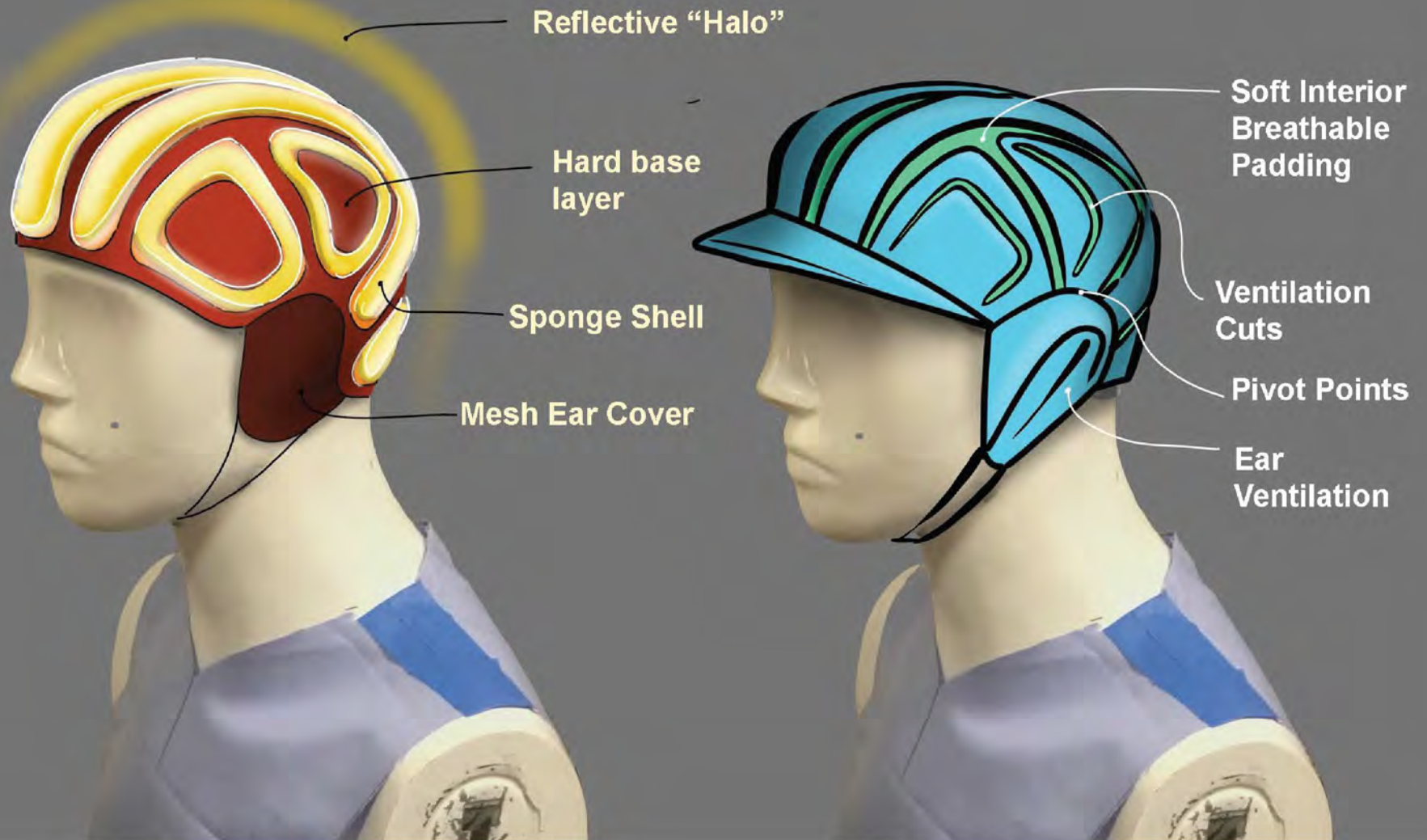

The Glowing Seed

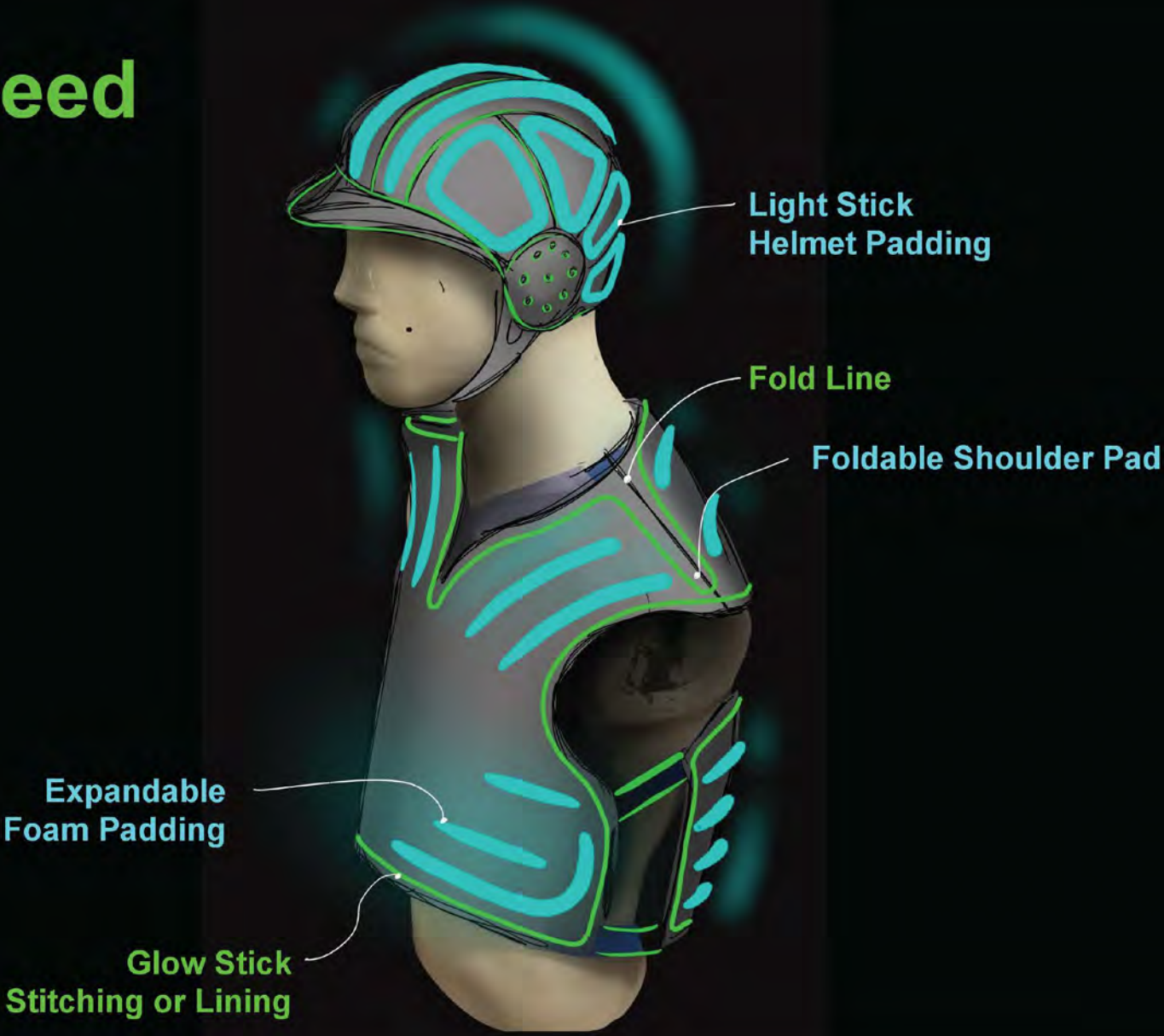

Light Stick
Helmet Padding

Fold Line

Foldable Shoulder Pad

Expandable
Foam Padding

Glow Stick
Stitching or Lining

The Evolution of Man

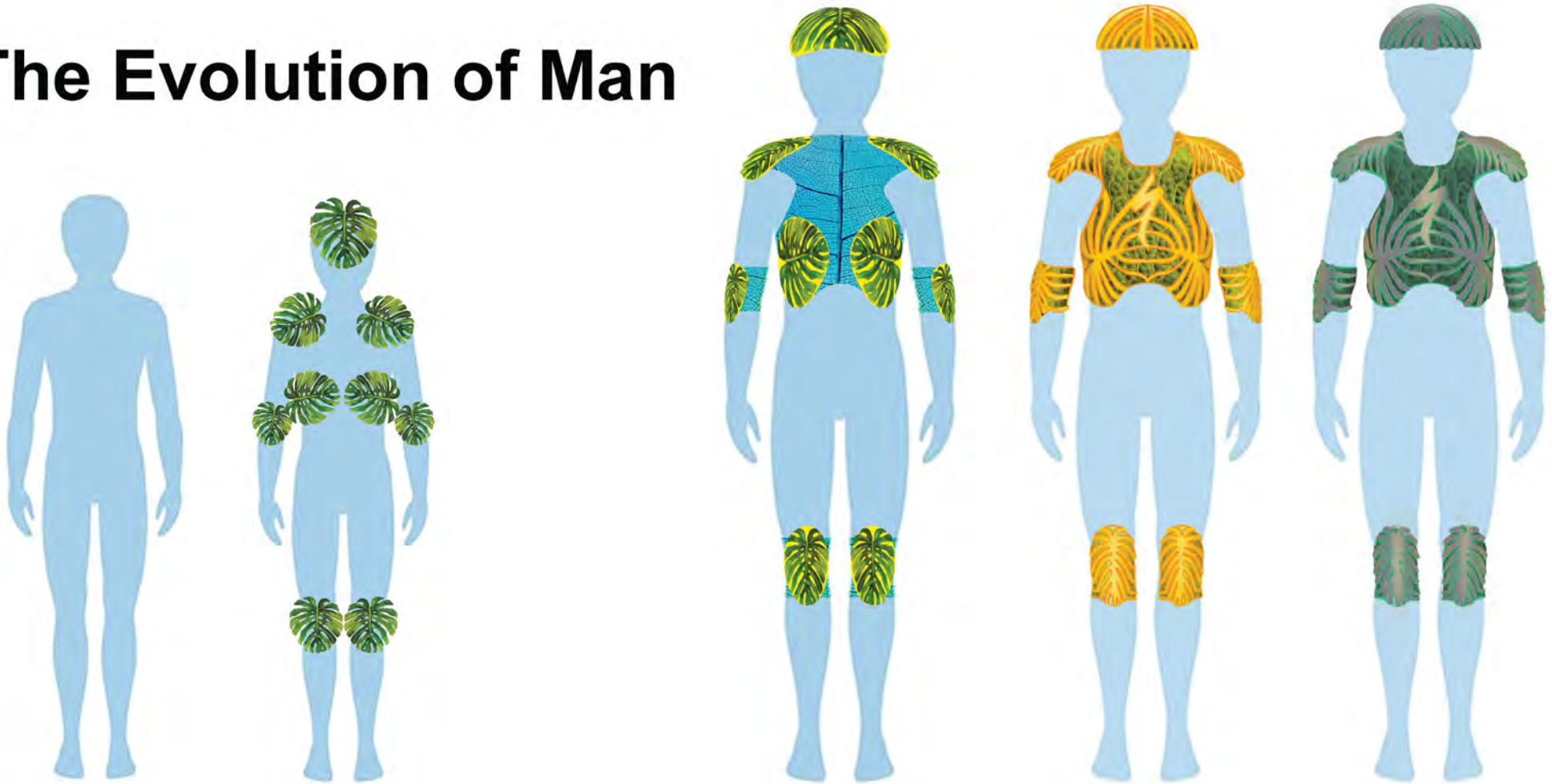

“Like early humans, we will once again use a leaf to protect.”

Monstera Leaf Design Influence

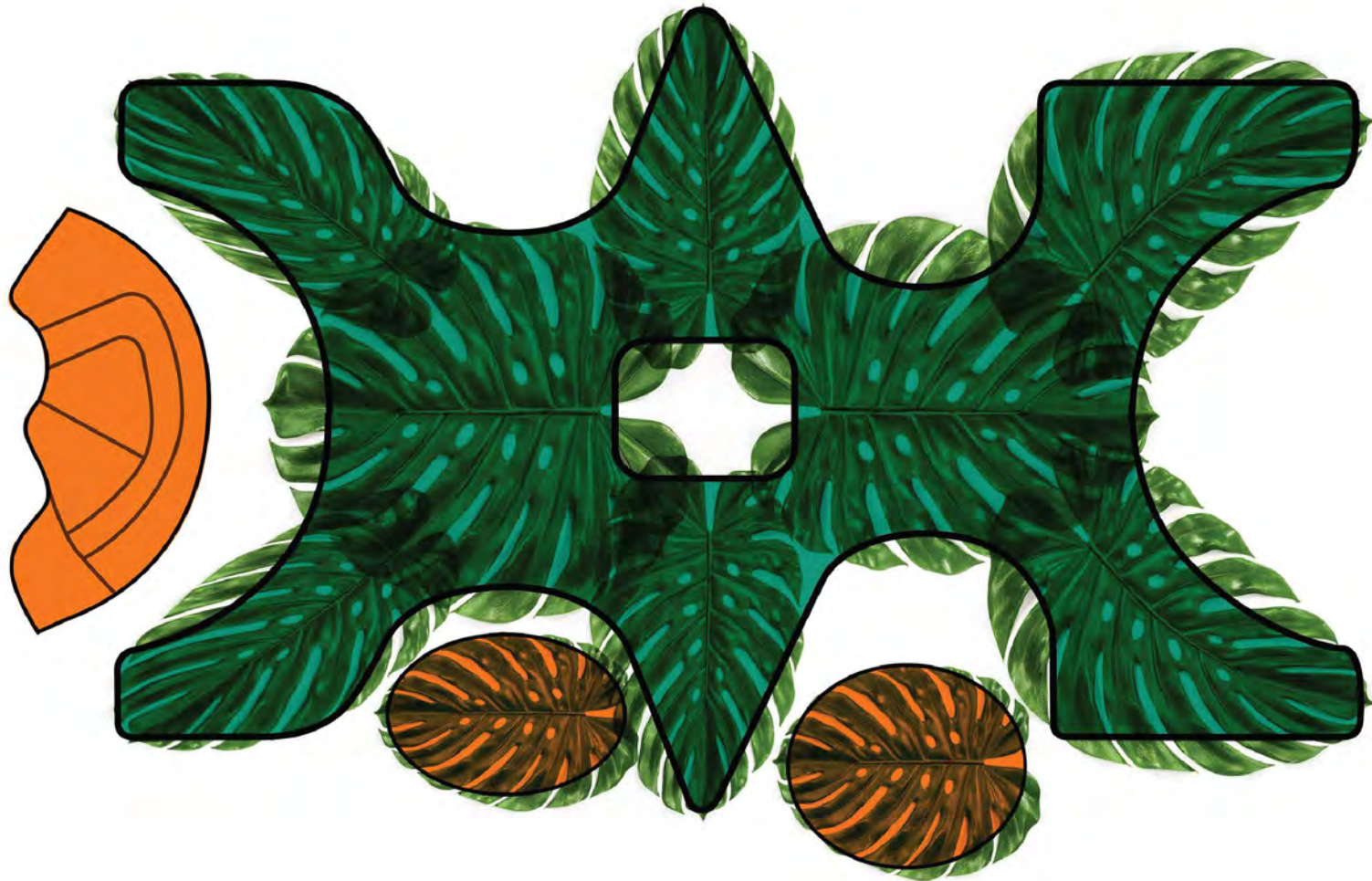

Locked In Leaf Design



NIGHT TIME GLOW

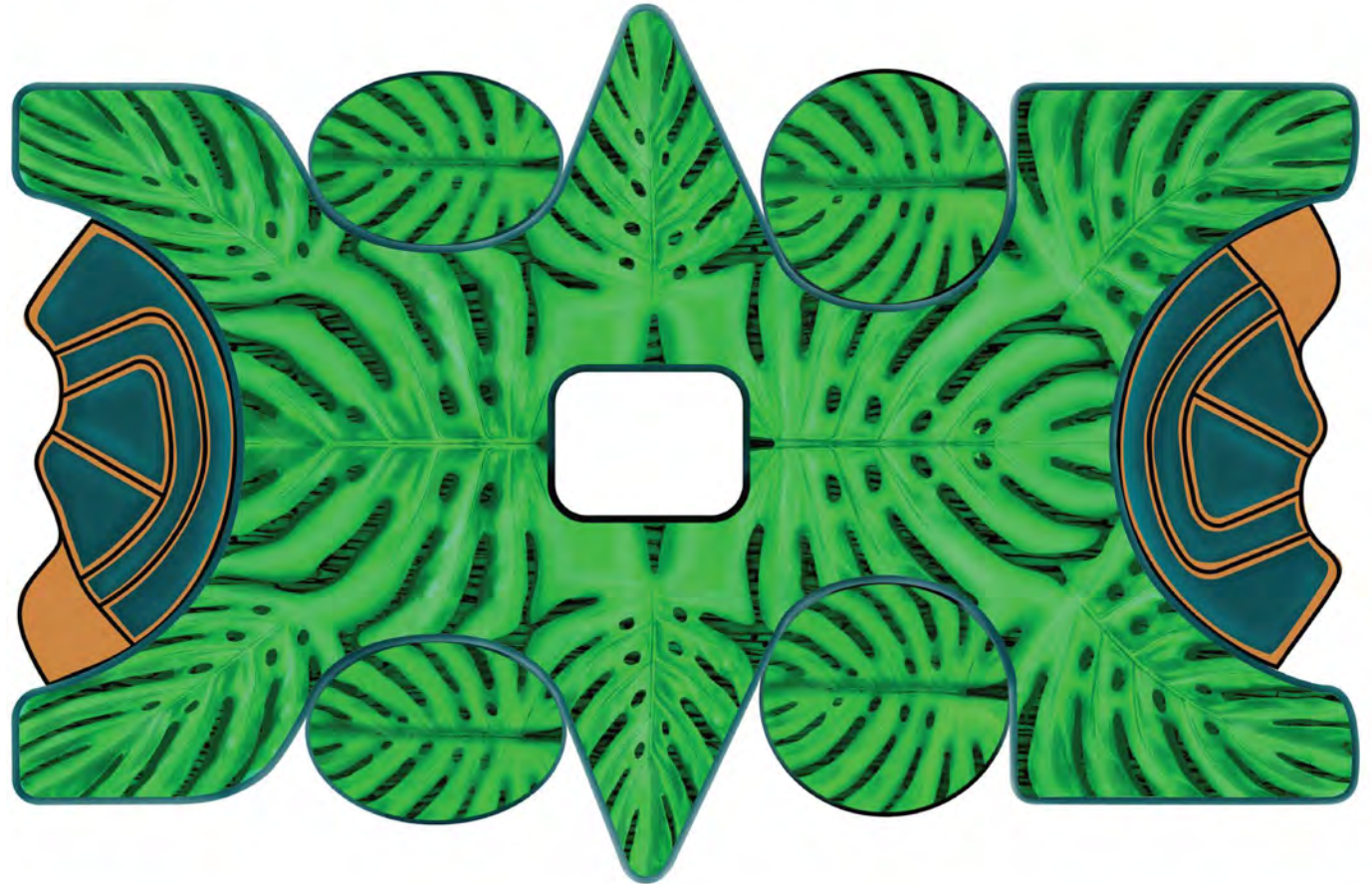

DAY TIME PADDING



FRONT



BACK



FRONT

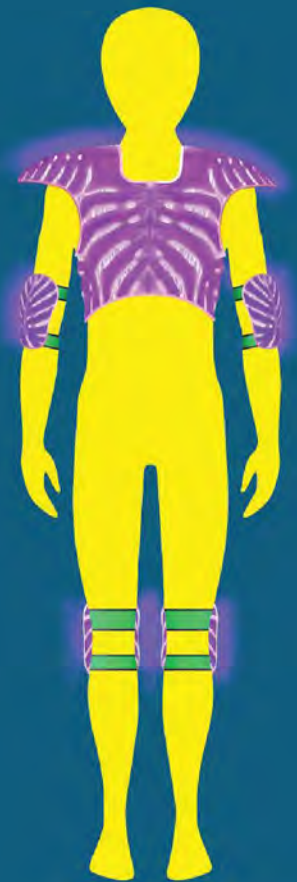

BACK

The Drifting Dreamers

“This was a revision of the original story to give it a COVID19 foundation that many will be able to relate to.”

It was the longest day of the summer. The **Solstice**. The **Dreamer** was trapped in a cage.



The air was suffocating. All the **Dreamer** wanted to do was ride with his friends.



The **Dreamer** wanted isolation and social distancing to end.
The **Dreamer** wanted to be with his friends.
The **Dreamer** wanted to be free.



The **Dreamer**'s father was ready for him to be free too.
Months of **preaching** to his son about home school.
Hours seeing him struggle concentrating on his homework.



The **Dreamer** thought his father's **preaching** was crazy.
He spent the entire quarantine **preaching**
about home school and paying attention.

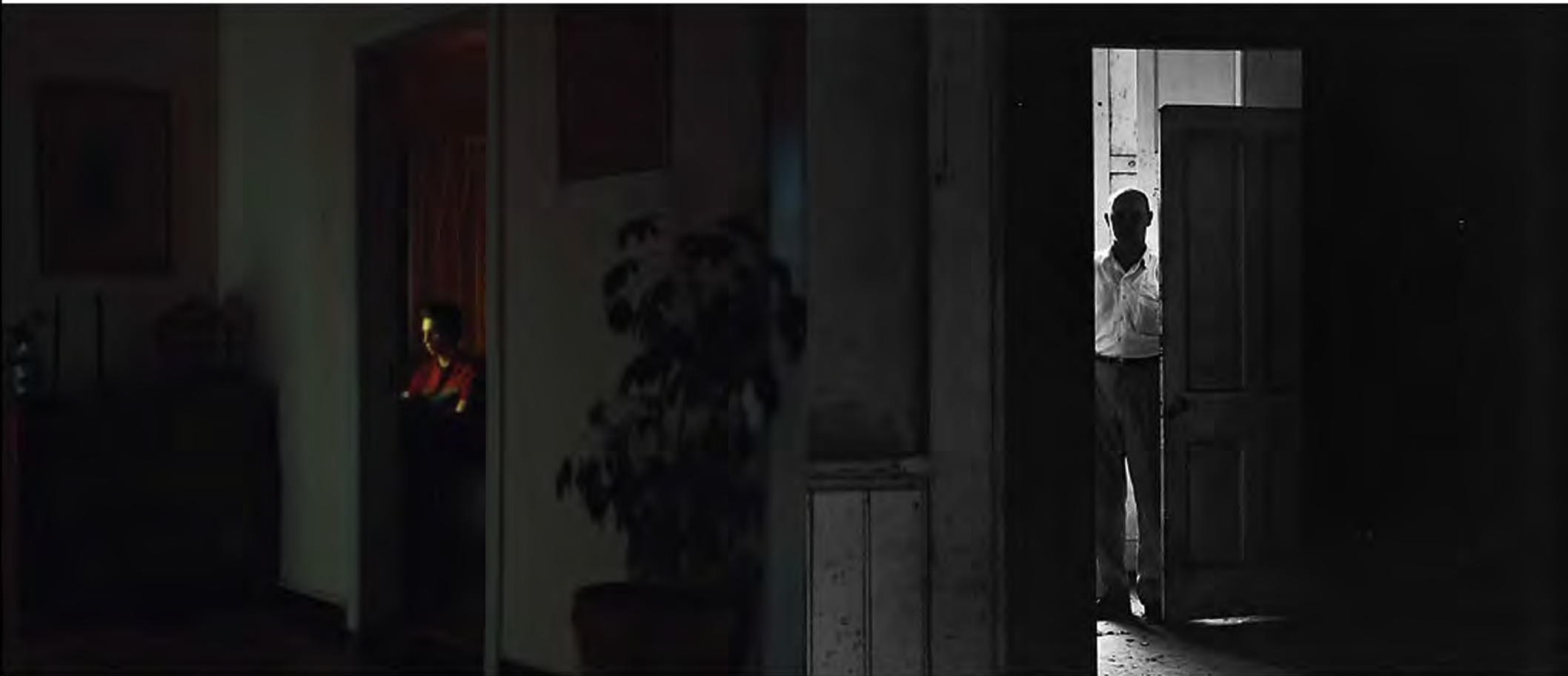

His father became the **Pandemonium Preacher**.

Until that night. The night of the **solstice**.



It was on the news.
It was all over, there was a cure.
The **Dreamer** was free.

His friends were ready.



They knew what this news meant to them.

The **Pandemonium Preacher** could see his son wanted to go outside.
He wanted the **Dreamer** to be safe from the wild.
He had a surprise for the **Dreamer**.

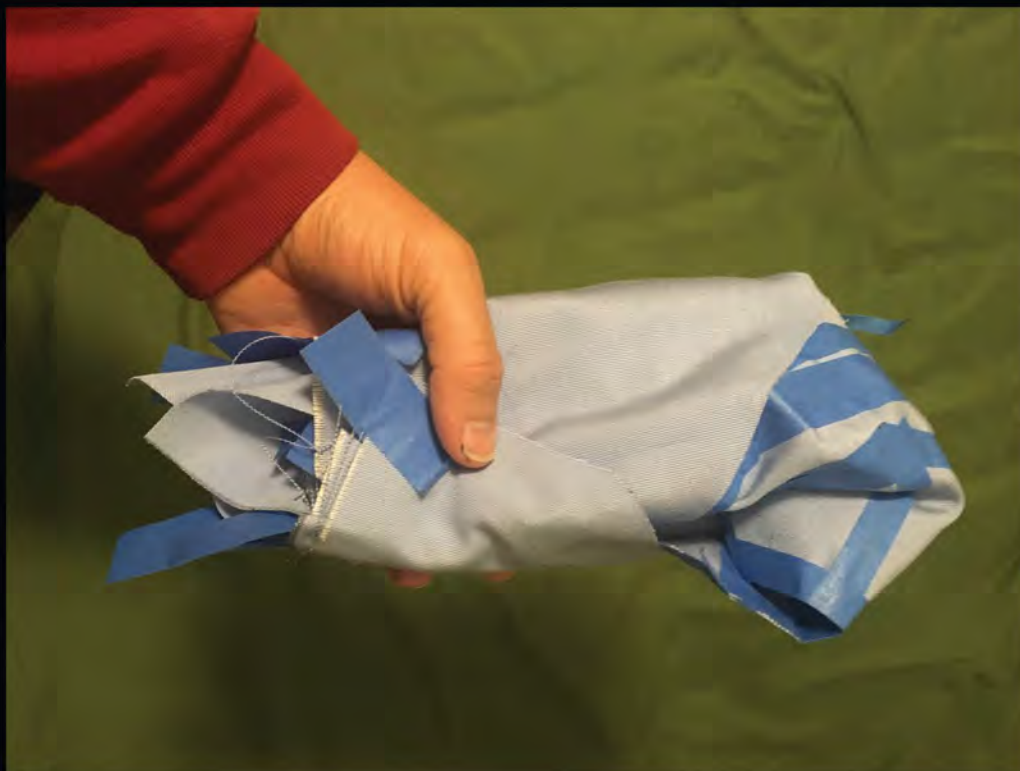

The **Pandemonium Preacher** presented the **Dreamer** with a Seed.

The **Dreamer** took the Seed and opened it.
Inside the Seed was a Leaf.

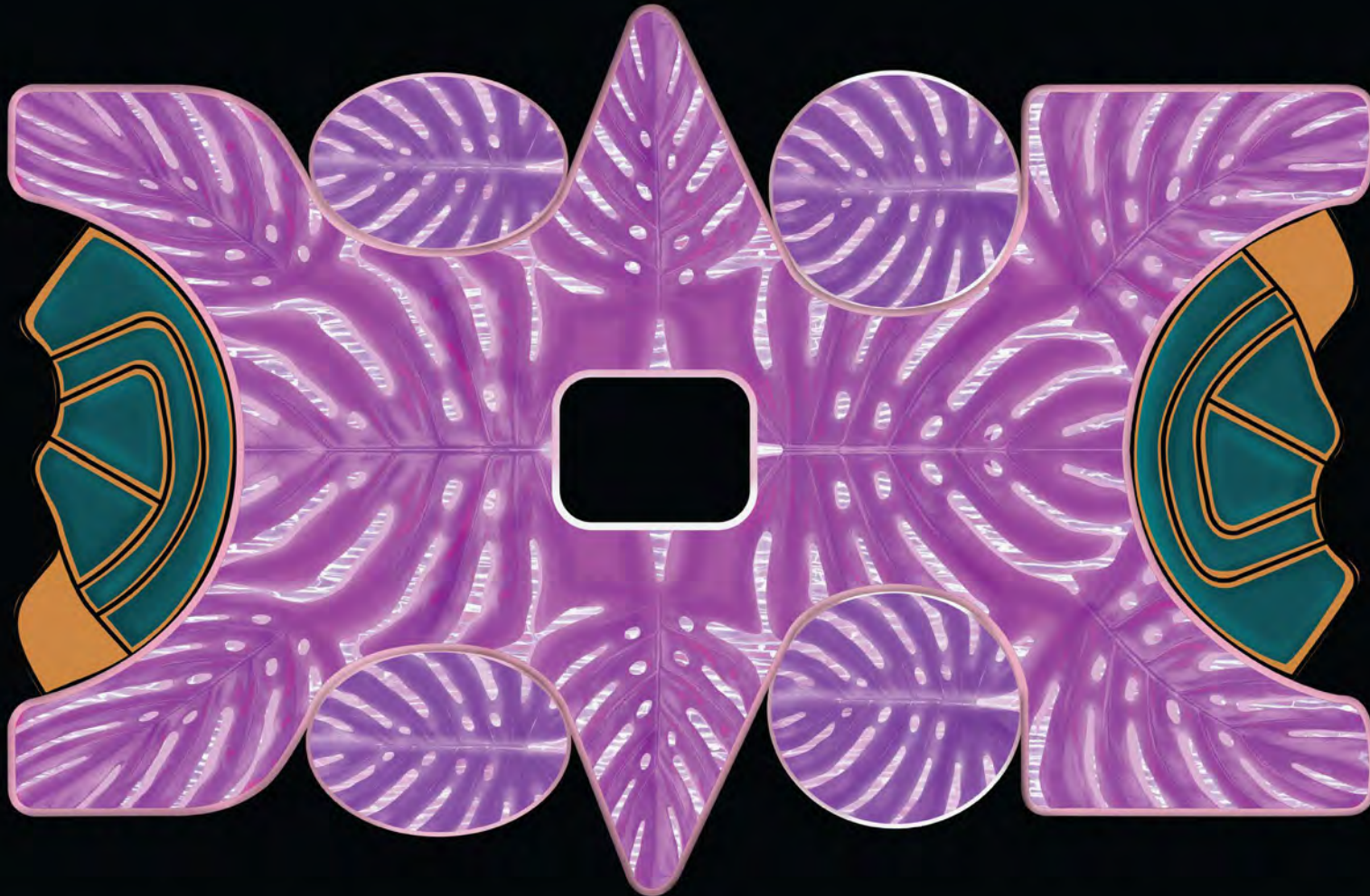

The LEAF and the SEED would protect the **Dreamer** from the dangers in the night.

The SEED provided a **Sanctuary**.
A **Sanctuary** from isolation
A **Sanctuary** from the summer **Solstice**.

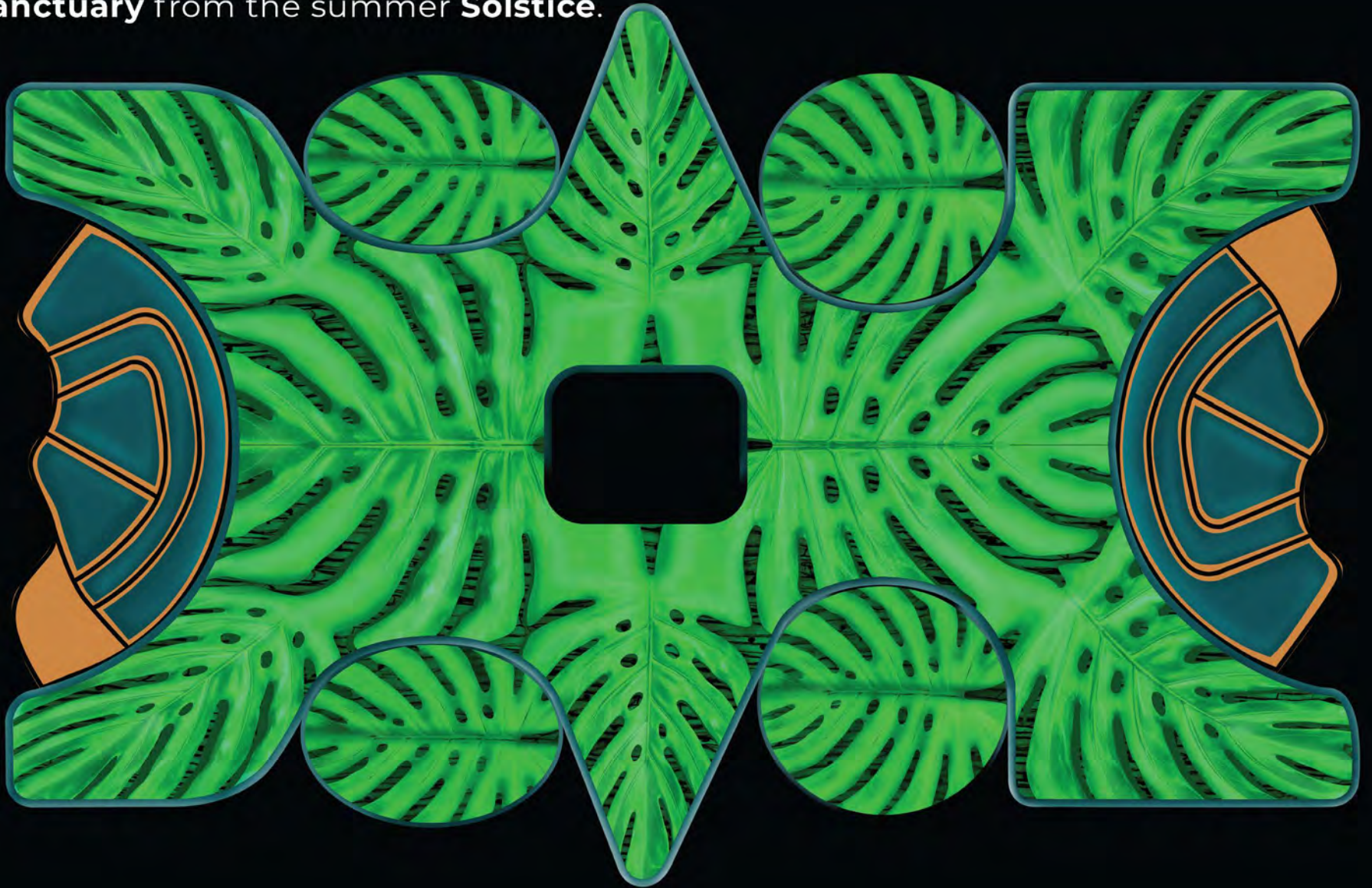

The **Pandemonium Preacher** watched the **Dreamer** put the LEAF on his body

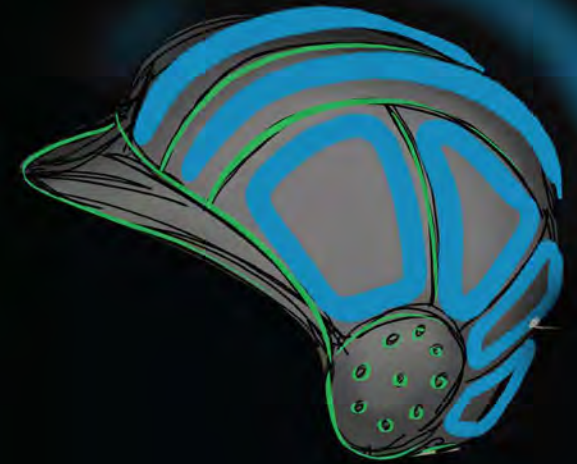
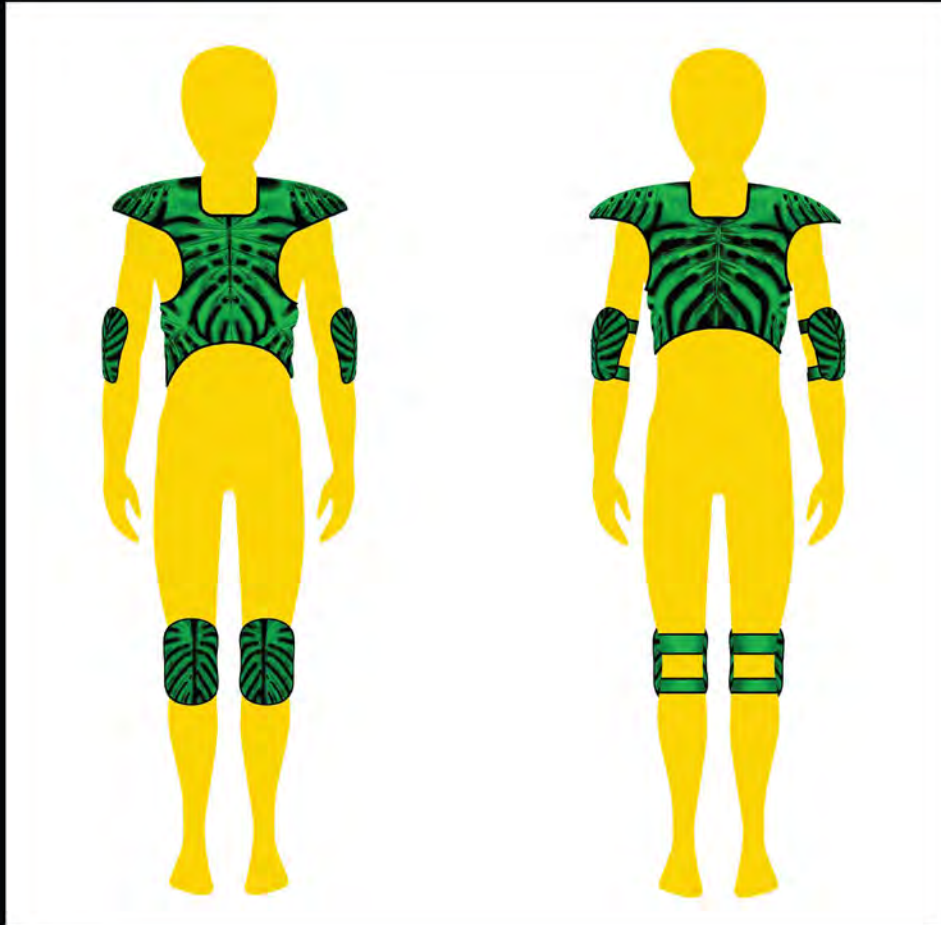

and finally put the SEED on his head.

Together they became the **Drifting Dreamers**.



Immediately the **Dreamer** rushed outside to feel the fresh night air of the **Solstice**.



The group was outside waiting.
They were all gifted the SEED too.
They all wanted to ride.

They all wanted to break free,
they wanted to roam the streets.



All night they were on their bikes **drifting** from neighborhood to neighborhood.



SPECIALIZED

LEAF

PROTECTION FROM THE WILD
WHEN YOU'RE ACTING WILD



WEEK 11-14

Design Freeze

Final

“These weeks were the mad rush to finals. Our presentations had to have video and convey a story arch of the whole term.

The following pages are my design for the final.”

Let's start at the beginning...

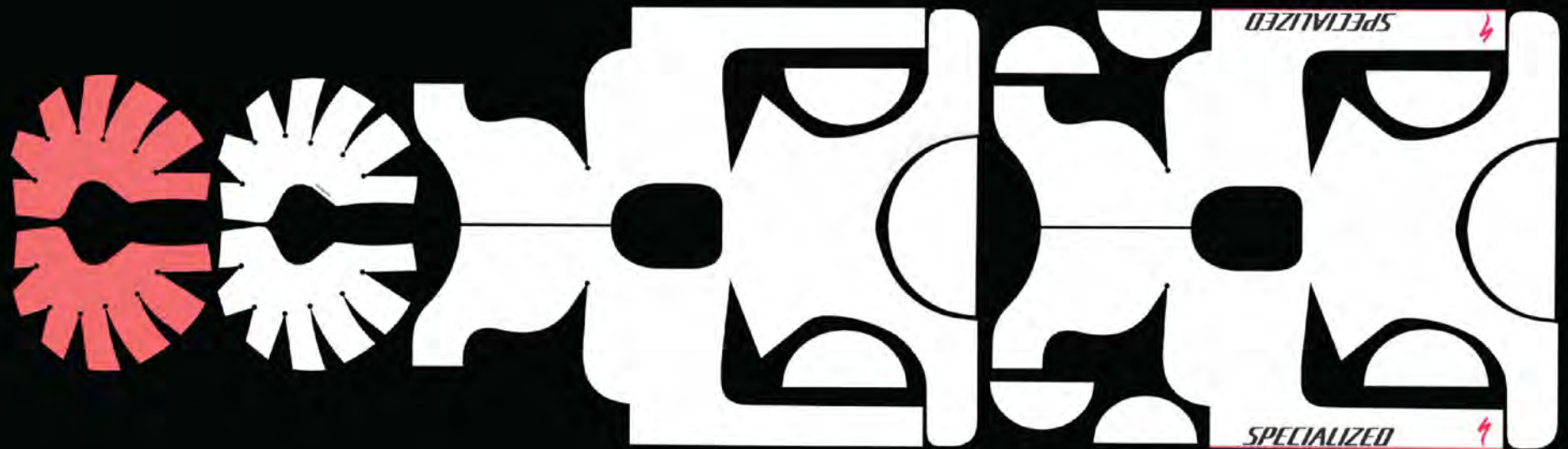

SEED starts as one flat pattern stamped out of 3M Reflective Scotchlite

STAGE 1

First layer of SEED



STAGE 2

Layer of D30 armor



STAGE 3

Third layer of SEED



STAGE 4

Ultrasonic welding



Then we add the GOO



“I discovered D-30 during the end of the ideation and during the beginning of the CMF ideation. It was an odd material that I instantly fell in love with.”



HELMET

BODY ARMOR

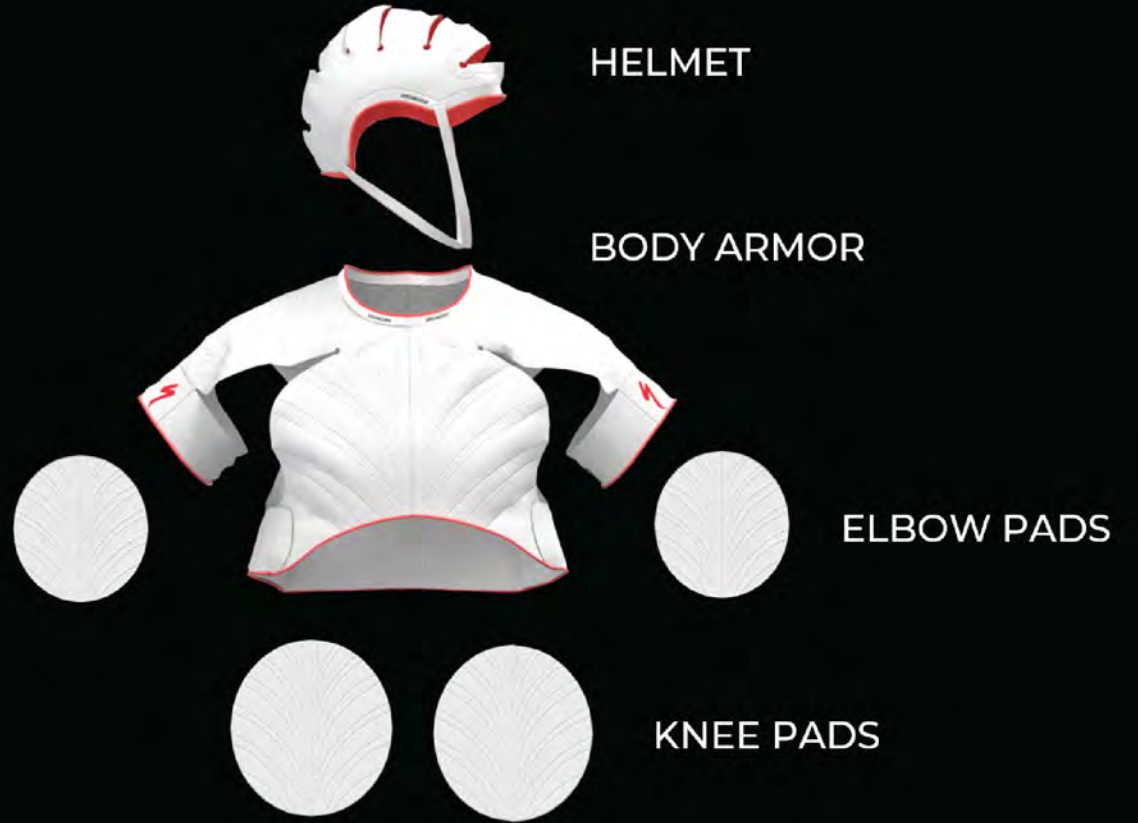

ELBOW PADS

KNEE PADS



Body Armor folds and collapses into a flat transportable size

Knee and Elbow pads fold into rear pocket



Armor fits into mobile SEED storage container



SEED

Foldable armor with moldable D30 cushioning for street bike riding.





COLOR OPTIONS



NIGHT SANCTUARY



MOON PREACHER



SOLSTICE HEAT



PANDEMONIUM DUSK



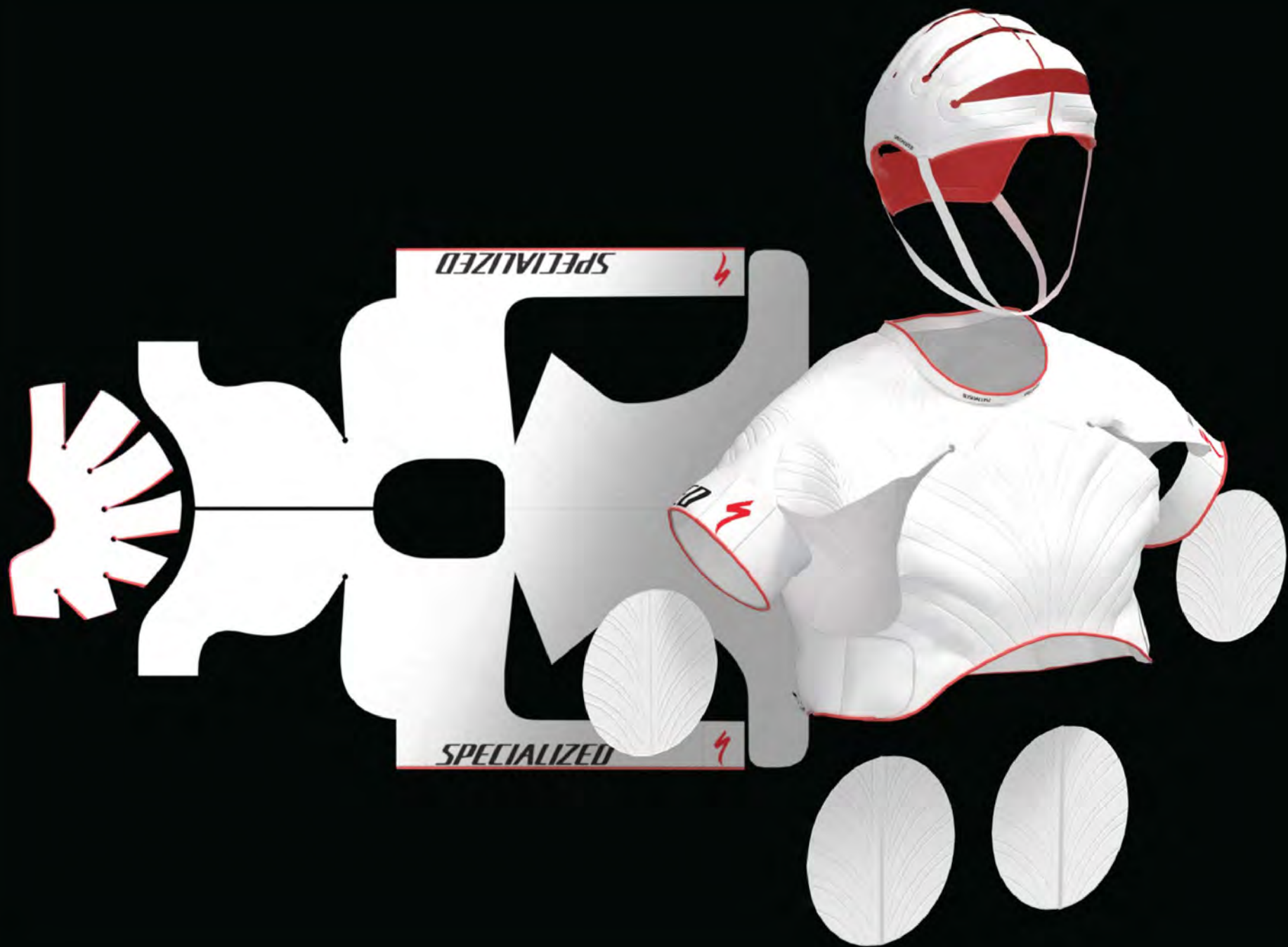

A large, expressive red brushstroke graphic that starts from the top left and sweeps downwards and to the right, crossing through the word 'SPECIALIZED'.

SPECIALIZED

LEAF

TO PROTECT YOU FROM THE WILD
WHILE YOU'RE ACTING WILD

WEEK 15+

“After the Week 14 final there were many positive comments and critiques.

Changes and improvements are still being made to the final design.

This is currently a work in progress.”